



Model Number

OMT600-R200-UEP-IO-0,3M-V1-L

Distance sensor
with fixed cable and M12 connector, 4-pin

Features

- Medium design with versatile mounting options
- Space-saving distance sensors in small standardized design
- Multi Pixel Technology (MPT) - exact and precise signal evaluation
- IO-link interface for service and process data
- Analog output 0 ... 10 V DC

Product information

The optical sensors in the series are the first devices to offer an end-to-end solution in a medium-sized standard design—from the thru-beam sensor through to the measuring distance sensor. As a result of this design, the sensors are able to perform practically all standard automation tasks. The entire series enables sensors to communicate via IO-Link. The DuraBeam laser sensors are durable and can be used in the same way as a standard sensor. Multi Pixel Technology (MPT) ensures that the standard sensors are flexible and can be adapted to the application environment.

Dimensions

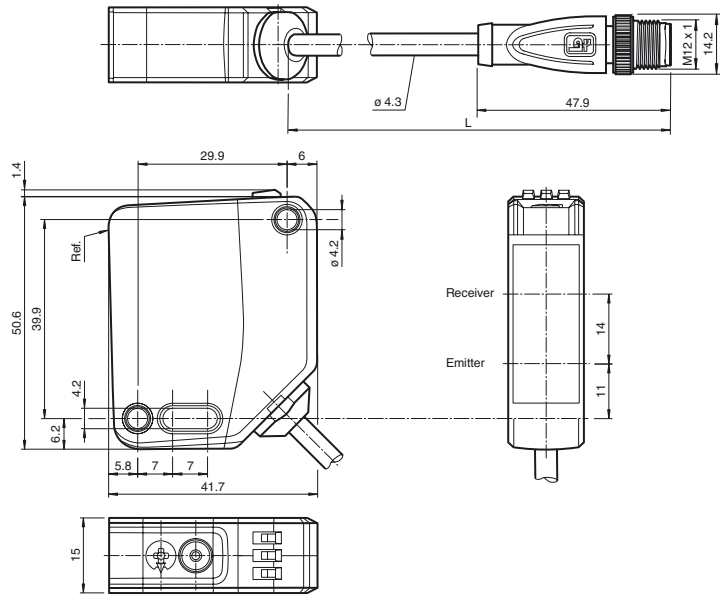

Electrical connection

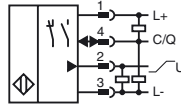

Pinout

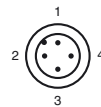

Wire colors in accordance with EN 60947-5-2

- 1 | BN (brown)
- 2 | WH (white)
- 3 | BU (blue)
- 4 | BK (black)

Indicators/operating means

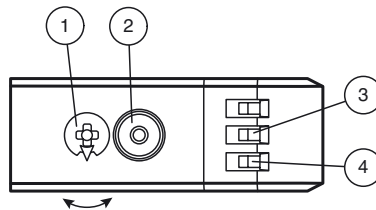

1	Mode rotary switch	
2	Teach-in button	
3	Switching output display Q1	YE
4	Operating indicator	GN

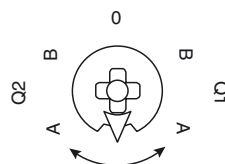

Q1B	Switching output/switch point B
Q1A	Switching output/switch point A
Q2A	Analog output/value A
Q2B	Analog output/value B
0	Keylock

Release date: 2019-07-01 10:57 Date of issue: 2019-10-31 295670-100310_eng.xml

Refer to "General Notes Relating to Pepperl+Fuchs Product Information".

Technical data**General specifications**

Measurement range	100 ... 600 mm
Reference target	standard white, 100 mm x 100 mm
Light source	laser diode
Light type	modulated visible red light
Laser nominal ratings	
Note	LASER LIGHT , DO NOT STARE INTO BEAM
Laser class	1
Wave length	680 nm
Beam divergence	> 5 mrad, $d_{63} < 2,8$ mm in the range of 350 mm ... 800 mm
Pulse length	5.5 μ s
Repetition rate	approx. 2.4 kHz
max. pulse energy	< 40 nJ
Angle deviation	max. +/- 1.5 °
Diameter of the light spot	approx. 3 mm at a distance of 600 mm
Angle of divergence	approx. 0.3 °
Ambient light limit	EN 60947-5-2 : 15000 Lux
Resolution	0.1 mm

Functional safety related parameters

MTTF _d	470 a
Mission Time (T _M)	20 a
Diagnostic Coverage (DC)	0 %

Indicators/operating means

Operation indicator	LED green: constantly on - power on flashing (4Hz) - short circuit flashing with short break (1 Hz) - IO-Link mode
Function indicator	LED yellow: constantly on - switch output active constantly off - switch output inactive
Control elements	Teach-In key
Control elements	5-step rotary switch for operating modes selection

Electrical specifications

Operating voltage	U _B	18 ... 30 V DC
Ripple		max. 10 %
No-load supply current	I ₀	< 18 mA at 24 V supply voltage
Protection class		III

Interface

Interface type	IO-Link (via C/Q = pin 4)
Device profile	Identification and diagnosis Smart Sensor type 0/type 3.3
Transfer rate	COM 2 (38.4 kBaud)
IO-Link Revision	1.1
Min. cycle time	3 ms
Process data width	Process data input 4 byte Process data output 2 bits
SIO mode support	yes
Device ID	0x111909 (1120521)
Compatible master port type	A

Output

Switching type	The default setting is: C/Q - Pin4: NPN normally open, PNP normally closed, IO-Link U—Pin2: analog output 0 ... 10 V	
Signal output	1 push-pull output , 1 analog output , short-circuit-proof, reverse polarity protection, surge-proof	
Switching voltage	max. 30 V DC	
Switching current	max. 100 mA , resistive load	
Usage category	DC-12 and DC-13	
Voltage drop	U _d	≤ 1.5 V DC
Response time	2 ms	

Analog output

Output type	1 voltage output: 0 ... 10 V
Load resistor	> 1 k Ω voltage output ; ≤ 470 Ω current output
Recovery time	2 ms

Conformity

Communication interface	IEC 61131-9
Product standard	EN 60947-5-2
Laser safety	EN 60825-1:2014

Measurement accuracy

Temperature drift	0.05 %/K
Warm up time	5 min
Repeat accuracy	< 1 %
Linearity error	0.75 %

Ambient conditions

Ambient temperature	10 ... 50 °C (50 ... 122 °F)
---------------------	------------------------------

Laserlabel**Accessories****V1-G-2M-PUR**

Female cordset, M12, 4-pin, PUR cable

V1-W-2M-PUR

Female cordset, M12, 4-pin, PUR cable

IO-Link-Master02-USB

IO-Link master, supply via USB port or separate power supply, LED indicators, M12 plug for sensor connection

OMH-MLV12-HWK

Mounting bracket for series MLV12 sensors

OMH-R200-01Mounting aid for round steel \varnothing 12 mm or sheet 1.5 mm ... 3 mm**OMH-R20x-Quick-Mount**

Quick mounting accessory

OMH-MLV12-HWG

Mounting bracket for series MLV12 sensors

Other suitable accessories can be found at www.pepperl-fuchs.com

Storage temperature	-40 ... 70 °C (-40 ... 158 °F)
Mechanical specifications	
Housing width	15 mm
Housing height	50.6 mm
Housing depth	41.7 mm
Degree of protection	IP67 / IP69 / IP69K
Connection	300 mm fixed cable with M12 x 1, 4-pin connector
Material	
Housing	PC (Polycarbonate)
Optical face	PMMA
Mass	approx. 45 g
Cable length	0.3 m

Approvals and certificates

UL approval	E87056 , cULus Listed , class 2 power supply , type rating 1
CCC approval	CCC approval / marking not required for products rated ≤ 36 V
FDA approval	IEC 60825-1:2014 Complies with 21 CFR 1040.10 and 1040.11 except for deviations pursuant to Laser Notice No. 50, dated June 24, 2007

Settings**Teach-In (TI)**

Use the rotary switch for switching signal **Q1** to select the relevant switching threshold A and/or B to teach in.

- The yellow LEDs indicate the current state of the selected output.

To teach in a switching threshold, press and hold the "TI" button for approximately 1 s, until the yellow and green LEDs flash in phase. Teach-in starts when the "TI" button is released.

- Teach-in successful: the yellow and green LEDs flash alternately at 2.5 Hz.
- Teach-in unsuccessful: the yellow and green LEDs quickly flash alternately at 8 Hz.

After an unsuccessful Teach-in, the sensor continues to operate with the previous valid setting after the relevant visual fault signal is issued.

Set switching mode: you can define different switching modes by teaching in the relevant distance data for switching thresholds A and B.

1. Single point mode:

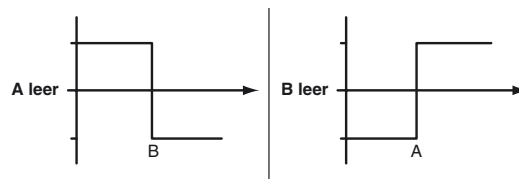

2. Window mode:

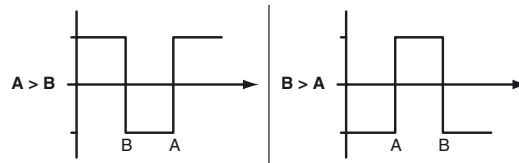

Teach in switching thresholds: you can teach in or overwrite a taught-in switching threshold at any time. To do this, press the "TI" button again.

Reset a value: you can reset a taught-in value. To do this, press the "TI" button for > 4 s, until the yellow and green LEDs go out. The reset process itself starts when the "TI" button is released.

- Reset successful: the yellow and green LEDs flash alternately at 2.5 Hz.

Minimum and maximum values for the analog output Q2 are taught in and deleted in the same way as those for the switching output.

The following applies:

A = Minimum voltage/current

B = Maximum voltage/current

Resetting to Factory Settings

To revert back to factory settings, press the "TI" button for > 10 s with the rotary switch set to position "O," until the yellow and green LEDs go out at the same time. The reset process itself starts when the "TI" button is released.

- Reset to factory settings successful: the yellow and green LEDs light up at the same time. The sensor then continues to operate with factory settings.

OMT-IEP

- Factory setting for switching signal Q1:
Switching signal is high active, window mode
- Analog output: current output, 4 mA ... 20 mA absolute mode

OMT-UEP

- Factory setting for switching signal Q1:
Switching signal is high active, window mode
- Analog output: voltage output, 0 V ... 10 V absolute mode

Analog output

The analog output type can be configured as voltage or current output via IO-Link.

The following output types are available:

- Analog output 0 mA ...20 mA
- Analog output 4 mA ...20 mA
- Analog output 0 V ...10 V

The following operating modes are available:

- Absolute mode (default setting)
- Normalized mode
- Rising slope
- Falling slope

The following substitute values can optionally be configured:

- No substitute values used (default setting)
- Substitute value for "no measured value" used
- Substitute value for "no measured value" and "Measuring overrange" used

The sensor's tolerances are based on the digital process data.

Absolute mode (default setting, A and B = deleted)

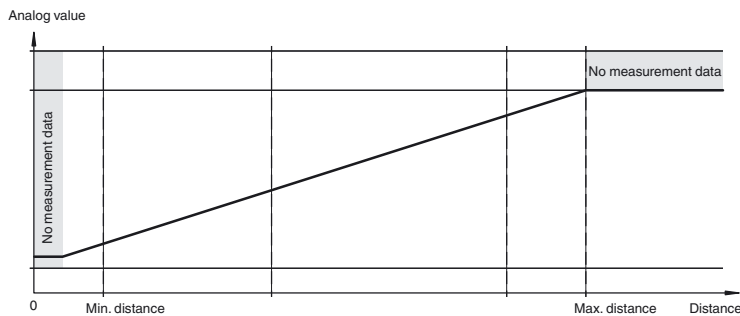

Normal mode (A and B without teach-in / deleted)

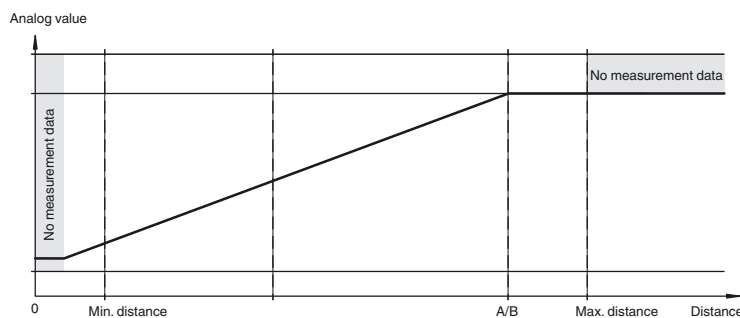

Rising slope (A < B)

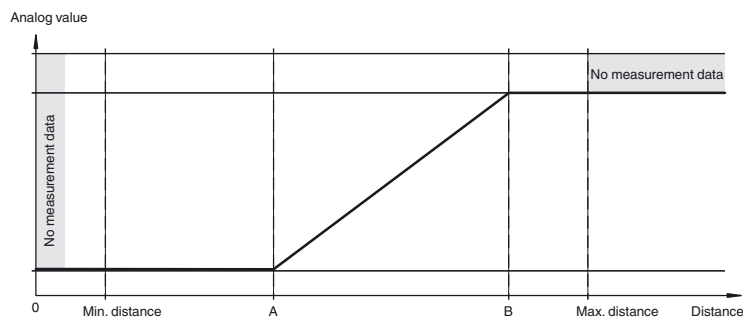

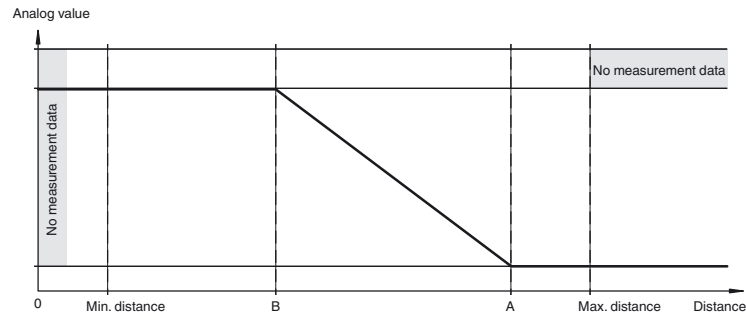
Falling slope (A > B)**Configuration via IO-Link interface****Setting different operating modes via the IO-Link interface**

The devices are equipped with an IO-Link interface as standard for diagnostics and parameterization tasks to ensure optimum adjustment of the sensors to the relevant application.

Single point mode operating mode (one switch point):

- "Detection of objects irrespective of type and color in a defined detection range. Objects in the background are suppressed.
- "The switch point corresponds exactly to the set point.

**Window mode operating mode (two switch points):**

- Detection of objects irrespective of type and color in a defined detection range. Reliable detection when object leaves the detection range.
- Window mode with two switch points.

**Center window mode operating mode (one switch point):**

- Detection of objects irrespective of type and color in a defined detection range. Sets a defined window around a given object. Objects outside this window are not detected.
- Window mode with one switch point.

**Two point mode operating mode (hysteresis operating mode):**

- Detection of objects irrespective of type and color between a defined switch-on and switch-off point.

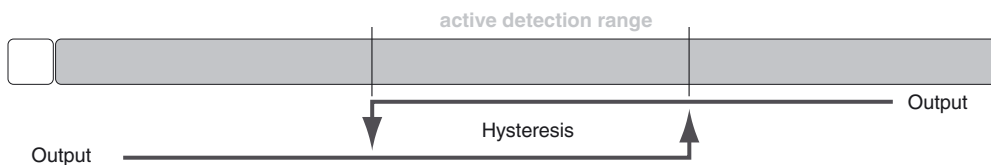
**Inactive operating mode:**

- Evaluation of switching signals is deactivated.

The associated IODD device description file can be found in the download area at www.pepperl-fuchs.com.