



**Model Number**

**SU18/35/40a/110/115/123**

Fiber optic sensor  
with fixed cable

**Features**

- Basic line for DIN rail installation
- High power version
- Sleek design
- 3 response times selectable
- Protected against mutual interference (no cross-talk)
- External TEACH-IN

**Dimensions**

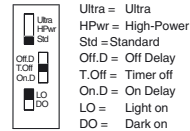
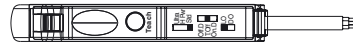
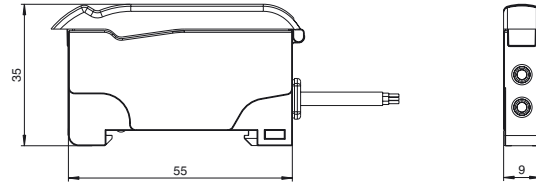

**Electrical connection**

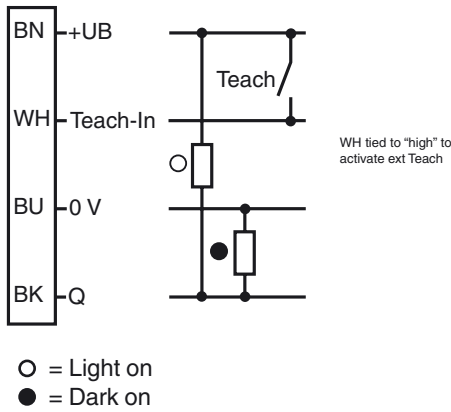

Release date: 2018-01-15 17:06 Date of issue: 2018-01-15 808703\_eng.xml

Refer to "General Notes Relating to Pepperl+Fuchs Product Information".

Pepperl+Fuchs Group  
www.pepperl-fuchs.com

USA: +1 330 486 0001  
fa-info@us.pepperl-fuchs.com

Germany: +49 621 776 4411  
fa-info@de.pepperl-fuchs.com

Singapore: +65 6779 9091  
fa-info@sg.pepperl-fuchs.com

**Technical data****General specifications**

Sensor range	up to 460 mm (KLR-C02-2,2-2,0-K146)
Detection range	up to 1500 mm (KLE-C01-2,2-2,0-K116)
Light source	LED
Light type	modulated visible red light , 640 nm
Ambient light limit	10000 Lux

**Functional safety related parameters**

MTTF <sub>d</sub>	690 a
Mission Time (T <sub>M</sub> )	20 a
Diagnostic Coverage (DC)	0 %

**Indicators/operating means**

Operation indicator	LED green, statically lit Power on , Undervoltage indicator: Green LED, pulsing (approx. 0.8 Hz) , short-circuit : LED green flashing (approx. 4 Hz)
Function indicator	LED yellow: static illumination switching state, flashes when falling short of the stability control
Control elements	Teach-In key slide switch 2 positions: light/dark switching slide switch 3 positions: timer function - timer off, on delay 40 ms, off-delay 40 ms slide switch 3 positions: operating mode - Standard, High Power, Ultra

**Electrical specifications**

Operating voltage	U <sub>B</sub>	10 ... 30 V DC
Ripple		10 %
No-load supply current	I <sub>0</sub>	≤ 30 mA

**Input**

Function input	external Teach-In
----------------	-------------------

**Output**

Switching type	light/dark on, switchable	
Signal output	1 push-pull (4 in 1) output NPN/PNP , short-circuit protected	
Switching voltage	max. 30 V DC	
Switching current	max. 100 mA , resistive load	
Voltage drop	U <sub>d</sub>	≤ 2 V DC at 100 mA ; ≤ 0.7 V at 10 mA
Switching frequency	f	Standard mode: 3 kHz , High power mode: 1 kHz , Ultra mode: 100 Hz
Response time		Standard mode: 160 μs , High power mode: 500 μs , Ultra mode: 5 ms
Repeat accuracy	R	≤ 0.5 % of adjusted sensor range

**Ambient conditions**

Ambient temperature	-10 ... 55 °C (14 ... 131 °F)
Storage temperature	-20 ... 70 °C (-4 ... 158 °F)

**Mechanical specifications**

Housing width	9 mm
Housing height	34.5 mm
Housing depth	62.3 mm
Degree of protection	IP50
Connection	2 m PVC cable, 4 x 0,14 mm <sup>2</sup>
Material	
Housing	PC
Mass	45 g

**Compliance with standards and directives**

Standard conformity	
Product standard	EN 60947-5-2:2007 IEC 60947-5-2:2007

**Approvals and certificates**

UL approval	cULus Listed, Class 2 Power Source, Type 1 enclosure
CCC approval	CCC approval / marking not required for products rated ≤36 V

**Accessories****HPF-D032**

**KLR-C02-2,2-2,0-K146**  
Plastic fiber optic - diffuse

**KLR-C02-2,2-2,0-K70**  
Plastic fiber optic - diffuse

**KLR-C02-1,0-2,0-K75**  
Plastic fiber optic - diffuse

**KLR-C09-1,25-2,0-K76**  
Plastic fiber optic - diffuse

**KLR-C09-1,25-2,0-K74**  
Plastic fiber optic - diffuse

**KLR-C16-2,2-2,0-K71**  
Plastic fiber optic - diffuse

**KLR-A32-2,2-2,0-K83**  
Plastic fiber optic - diffuse

**KHR-C02-2,2-2,0-K131**  
Plastic fiber optic - diffuse

**KHTR-C02-2,2-2,0-K88**  
Plastic fiber optic - diffuse

**LHR 00-0,8-1,0-20M4**  
Glass fiber optic - diffuse with silicon covering

**KLE-C01-2,2-2,0-K116**  
Plastic fiber optic - thru-beam

**KLE-C01-2,2-2,0-K103**  
Plastic fiber optic - thru-beam

**KLE-C01-2,2-2,0-K102**  
Plastic fiber optic - thru-beam

**KLE-C01-2,2-2,0-K100**  
Plastic fiber optic - thru-beam

**KLE-C01-2,2-2,0-K101**  
Plastic fiber optic - thru-beam

**KLE-C01-2,2-2,0-K113**  
Plastic fiber optic - thru-beam

**KLE-C01-1,0-2,0-K120**  
Plastic fiber optic - thru-beam

**KHE-C01-2,2-2,0-K122**  
Plastic fiber optic - thru-beam

**KHTE-C01-2,2-2,0-K118**  
Plastic fiber optic - thru-beam

**LHE 00-1,1-1,0-20M4**  
Glass fiber optic - thru-beam with silicon covering

**Bracket SU**  
Mounting bracket for DIN rail

Other suitable accessories can be found at  
[www.pepperl-fuchs.com](http://www.pepperl-fuchs.com)

## Curves/Diagrams

### LED indicators and operating chart:

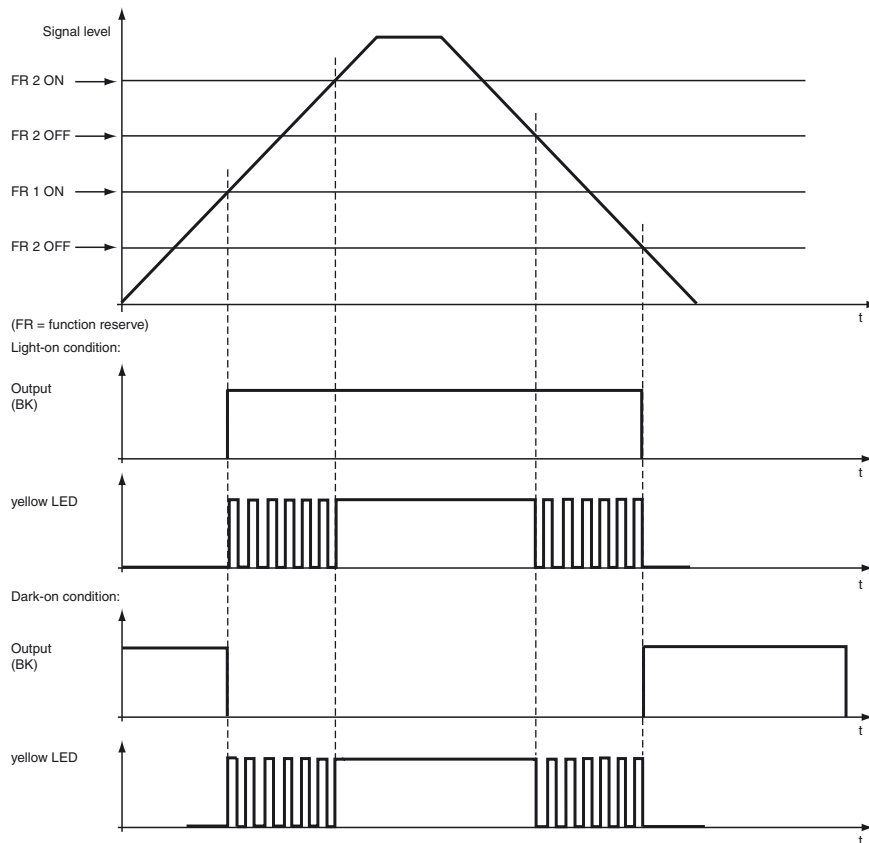

## Teach-in procedures

### 2-Point Teach\*:

1. Place the first target to be learned.
  2. Press and hold the Teach button for > 2 seconds to enter Teach mode.
  3. Press for another 3 second, both LEDs switch off for 1 second to indicate that you are now in 2-point teach mode.
  4. Remove the target (to teach the background) or move the target further away.
  5. Press the Teach button for < 2 seconds to end Teach mode.
- Both LEDs will indicate fast in-phase blinking and then alternate blinking to signal end of Teach mode. 2-Point Teach is completed.

\* Remarks: The 2-point Teach-in can be used for thru-beam and diffuse mode applications. The teach-in takes in this case in the reverse order.

1. Object absent (light path free).
4. Object present.

### Dynamic Teach:

1. Press and hold the Teach button for > 2 seconds to enter Teach mode. Both LEDs will indicate fast in-phase blinking follow by slow in-phase blinking.
2. Pass a moving target.
3. Press and hold the Teach button for < 2 seconds to end Teach mode. Both LEDs will indicate alternate blinking to signal end of Teach mode.

### Maximum Teach:

1. Remove target
2. Press and hold the Teach button for > 2 seconds to enter Teach mode. Both LEDs will indicate fast in-phase blinking follow by slow in-phase blinking.
3. Press and hold the Teach button for > 2 seconds to end Teach mode. Both LEDs will indicate fast in-phase blinking and then alternate blinking to signal end of Teach mode.

### Position Teach:

1. Place a target.
2. Press and hold the Teach button for > 2 second to enter Teach mode. Both LEDs will indicate fast in-phase blinking follow by slow in-phase blinking. If the target is too near (strong signal), the fast blinking will last slightly longer follow by slow blinking.
3. Press and hold the Teach button for > 2 seconds to end Teach mode. Both LEDs will indicate fast in-phase blinking and then

alternate blinking to signal end of Teach mode.

**Indications for the Green and Yellow LEDs in detection mode (normal operation):**

- Yellow LED is stable ON to indicate that signal received is > FR2.
- Yellow LED will flash at 4 Hz to indicate function reserve,  $FR1 < \text{signal level} < FR2$ .
- Green LED stable ON to indicate power supply is ON, sensor is ready.
- Green LED will flash once for each key actuation, e.g. actuation of the Teach button.
- Green LED will flash at 4 Hz to indicate a short-circuit fault at the output(s).
- Green LED will flash at 0.8 Hz dual flashing to indicate an under-voltage fault at the power supply.

**Indications for the Green and Yellow LEDs in the Teach Mode:**

- Yellow & Green LEDs in-phase blinking indicates that the sensor has entered the Teach Mode.
- Slow Yellow & Green LEDs in-phase blinking indicates that the sensor is ready or it is waiting to learn new information about the target and/or the background.
- Fast Yellow & Green LEDs in-phase blinking means that the sensor is in the progress of learning new target. When the learning is complete, slow in-phase blinking will be resumed as before.
- Green & Yellow LEDs flash alternately at 8 Hz indicates there has been a Teach fault or Teach error.
- Green & Yellow LEDs flash alternately at 2.5 Hz indicates the end of successful Teach.

**Remote Teach (Teach by wire)**

**External Teach in Standard, Hi Power or Ultra mode:**

1. Connect the external Teach wire (WH) to either “High” (for push-pull type) or to “Low” (for NPN type) to activate the external Teach mode. Once in the Teach mode, both LED’s will indicate fast in-phase blinking followed by slow in-phase blinking.
2. Pass a moving target.
3. Release or disconnect the external Teach wire (WH) to end Teach mode. Both LED’s will indicate alternate blinking to signal end of Teach mode. External Teach is now completed.

**Indications for the Green and Yellow LEDs in detection mode (normal operation):**

- Yellow LED is stable ON to indicate that signal received is > FR2
- Yellow LED will flash at 4 Hz to indicate function reserve,  $FR1 < \text{signal level} < FR2$
- Green LED stable ON to indicate power supply is ON, sensor is ready.
- Green LED will flash once for each key actuation, e.g. actuation of the Teach button
- Green LED will flash at 4 Hz to indicate a short-circuit fault at the output(s)
- Green LED will flash at 0.8 Hz to indicate an under voltage fault at the power supply

**Indications for the Green and Yellow LEDs in the Teach Mode:**

- Yellow & Green LEDs in-phase blinking indicates that the sensor has entered the Teach Mode
- Slow Yellow & Green LEDs in-phase blinking indicates that the sensor is ready or it is waiting to learn new information about the target and/or the background
- Fast Yellow & Green LEDs in-phase blinking means that the sensor is in the progress of learning new target. When the learning is complete, slow in-phase blinking will be resumed as before
- Green & Yellow LEDs flash alternately at 8 Hz indicates there has been a Teach fault or Teach error
- Green & Yellow LEDs flash alternately at 2.5 Hz indicates the End of successful Teach

**Selection table - thru-beam fiber optic cable**

Head shape	Moun-ting	Model number	Core	Detection distance *	Fiber cross section	minimum Object size	Fiber optic length	Bend radius	Dimensions	Special features
Highly precise										
Threaded	M3	KLE-C01-1.0-2.0-K120	PMMA	Ultra: 80 mm HiPwr: 45 mm Std: 20 mm	0.25 mm	0.05 mm	2 m	min. 10 mm		
Threaded	M4	KLE-C01-1.0-2.0-K119	PMMA	Ultra: 80 mm HiPwr: 45 mm Std: 20 mm	0.25 mm	0.05 mm	2 m	min. 10 mm		4 x high Detection range with Auxiliary lens K-LA01/ 8 x high Detection range with Auxiliary lens K-LA06/ Side view / Periscope with K-LA02
Threaded	M3 x 0.5	KLE-C04-1.0-2.0-K104	PMMA	Ultra: 300 mm HiPwr: 165 mm Std: 70 mm	4 x 0.25 mm	0.12 mm	2 m	min. 15 mm		

Release date: 2018-01-15 17:06 Date of issue: 2018-01-15 808703\_eng.xml

Head shape	Moun-ting	Model number	Core	Detection distance *	Fiber cross section	minimum Object size	Fiber optic length	Bend radius	Dimensions	Special features
Cylindrical	dia. 2 mm	KLE-C01-1.0-2.0-K105	PMMA	Ultra: 80 mm HiPwr: 45 mm Std: 20 mm	0.25 mm	0.05 mm	2 m	min. 10 mm		
Cylindrical	dia. 1.5 mm	KLE-C01-1.0-2.0-K107	PMMA	Ultra: 80 mm HiPwr: 45 mm Std: 20 mm	0.25 mm	0.05 mm	2 m	min. 10 mm		
Cylindrical	dia. 1.5 mm	KLE-C04-1.0-2.0-K108	PMMA	Ultra: 300 mm HiPwr: 165 mm Std: 70 mm	4 x 0.25 mm	0.12 mm	2 m	min. 15 mm		
Cylindrical	dia. 2 mm	KLE-C04-1.0-2.0-K106	PMMA	Ultra: 300 mm HiPwr: 165 mm Std: 70 mm	4 x 0.25 mm	0.05 mm	2 m	min. 15 mm		
Highly flexible										
Threaded	M3	KHE-C01-1.0-2.0-K125	PMMA	Ultra: 210 mm HiPwr: 120 mm Std: 50 mm	0.5 mm	0.15 mm	2 m	min. 1 mm		only 1 mm Bend radius
Threaded	M3	KHE-C01-2.2-2.0-K122	PMMA	Ultra: 800 mm HiPwr: 480 mm Std: 200 mm	1 mm	0.25 mm	2 m	min. 2 mm		only 2 mm Bend radius
Threaded	M4 x 0.7 / M2.6	KHE-C01-1.0-2.0-K124	PMMA	Ultra: 210 mm HiPwr: 120 mm Std: 50 mm	0.5 mm	0.15 mm	2 m	min. 1 mm		4 x high Detection range with Auxiliary lens K-LA01/ 8 x high Detection range with Auxiliary lens K-LA06 Side view / Periscope with K-LA02/ only 1 mm Bend radius
Threaded	M6	KHE-C01-2.2-2.0-K121	PMMA	Ultra: 800 mm HiPwr: 480 mm Std: 200 mm	1.0 mm	0.25 mm	2 m	min. 2 mm		only 2 mm Bend radius
Cylindrical	dia. 1.5 mm	KHE-C01-1.0-2.0-K139	PMMA	Ultra: 210 mm HiPwr: 120 mm Std: 50 mm	0.5 mm	0.05 mm	2 m	min. 1 mm		only 1 mm Bend radius
Cylindrical	dia. 3 mm	KHE-C01-2.2-2.0-K126	PMMA	Ultra: 210 mm HiPwr: 120 mm Std: 50 mm	0.5 mm	0.15 mm	2 m	min. 1 mm		only 1 mm Bend radius
Cylindrical	dia. 3 mm	KHE-C01-2.2-2.0-K123	PMMA	Ultra: 800 mm HiPwr: 480 mm Std: 200 mm	1 mm	0.25 mm	2 m	min. 2 mm		only 2 mm Bend radius

Release date: 2018-01-15 17:06 Date of issue: 2018-01-15 808703\_eng.xml

Refer to "General Notes Relating to Pepperl+Fuchs Product Information".

Pepperl+Fuchs Group  
www.pepperl-fuchs.com

USA: +1 330 486 0001  
fa-info@us.pepperl-fuchs.com

Germany: +49 621 776 4411  
fa-info@de.pepperl-fuchs.com

Singapore: +65 6779 9091  
fa-info@sg.pepperl-fuchs.com

Head shape	Moun-ting	Model number	Core	Detection distance *	Fiber cross section	minimum Object size	Fiber optic length	Bend radius	Dimensions	Special features
Right angle	dia. 15 x 5	KHE-C01-2.2-2.0-K137	PMMA	Ultra: 140 mm HiPwr: 80 mm Std: 35 mm	0.5 mm	0.15 mm	2 m	min. 1 mm		only 1 mm Bend radius
Right angle	dia. 15 x 5	KHE-C01-2.2-2.0-K140	PMMA	Ultra: 600 mm HiPwr: 350 mm Std: 150 mm	1 mm	0.25 mm	2 m	min. 2 mm		only 2 mm Bend radius
<b>Flexible</b>										
Threaded	M3 x 0.5 /M2.6	KLE-C01-1.3-2.0-K112	PMMA	Ultra: 800 mm HiPwr: 480 mm Std: 200 mm	1 mm	0.25 mm	2 m	min. 25 mm		4 x high Detection range with Auxiliary lens K-LA01/ 8 x high Detection range with Auxiliary lens K-LA06 Side view / Periscope with K-LA02
Threaded	M3 x 0.5	KLE-C01-2.2-2.0-K103	PMMA	Ultra: 920 mm HiPwr: 520 mm Std: 220 mm	1 mm	0.25 mm	2 m	min. 25 mm		
Threaded	M4 x 0.7 /M2.6	KLE-C01-2.2-2.0-K102	PMMA	Ultra: 920 mm HiPwr: 520 mm Std: 220 mm	1 mm	0.25 mm	2 m	min. 25 mm		4 x high Detection range with Auxiliary lens K-LA01/ 8 x high Detection range with Auxiliary lens K-LA06 Side view / Periscope with K-LA02
Threaded	M6	KLE-C01-2.2-2.0-K100	PMMA	Ultra: 920 mm HiPwr: 520 mm Std: 220 mm	1 mm	0.32 mm	2 m	min. 25 mm		
Threaded	M2.6	KLE-C01-2.2-2.0-K113	PMMA	Ultra: 800 mm HiPwr: 480 mm Std: 200 mm	1 mm	0.25 mm	2 m	min. 25 mm		4 x high Detection range with Auxiliary lens K-LA01/ 8 x high Detection range with Auxiliary lens K-LA06 Side view / Periscope with K-LA02
Cylindrical	dia. 2 mm	KLE-C01-1.3-2.0-K114	PMMA	Ultra: 920 mm HiPwr: 520 mm Std: 220 mm	1 mm	0.25 mm	2 m	min. 25 mm		
Cylindrical	dia. 5 mm	KLE-C01-2.2-2.0-K101	PMMA	Ultra: 920 mm HiPwr: 520 mm Std: 220 mm	1 mm	0.32 mm	2 m	min. 25 mm		
<b>Bendable tip</b>										
Threaded	M4	KLE 00-2.2-2.0-K55	PMMA	Ultra: 872 mm HiPwr: 500 mm Std: 228 mm	1 mm		2 m	min. 25 mm		
<b>High detection range</b>										
Threaded	M3	KLE-C01-2.2-2.0-K116	PMMA	Ultra: 1500 mm HiPwr: 950 mm Std: 450 mm	1.5 mm	0.35 mm	2 m	min. 40 mm		

Release date: 2018-01-15 17:06 Date of issue: 2018-01-15 808703\_eng.xml

Head shape	Moun-ting	Model number	Core	Detection distance *	Fiber cross section	minimum Object size	Fiber optic length	Bend radius	Dimensions	Special features
Threaded	M6	KLE-C01-2.2-2.0-K115	PMMA	Ultra: 1500 mm HiPwr: 950 mm Std: 450 mm	1.5 mm	0.35 mm	2 m	min. 40 mm		
Threaded	M8 x 1	FEF-PLT1	PMMA	Ultra: 25620 mm HiPwr: 15070 mm Std: 6000 mm calculated values related on 2 m Fiber optic length	1 mm		1 m	min. 25 mm		Narrow beam
Threaded	M8 x 1	FEF-PLT1-L2	PMMA	Ultra: 25620 mm HiPwr: 15070 mm Std: 6000 mm calculated values related on 2 m Fiber optic length	1 mm		2 m	min. 25 mm		Narrow beam
Threaded	M8 x 1	FEF-PLT1-L5	PMMA	Ultra: 25620 mm HiPwr: 15070 mm Std: 6000 mm calculated values related on 2 m Fiber optic length	1 mm		4 m	min. 25 mm		Narrow beam
Cylindrical	dia. 3 mm	KLE-C01-2.2-2.0-K117	PMMA	Ultra: 1360 mm HiPwr: 820 mm Std: 400 mm	1.5 mm	0.35 mm	2 m	min. 25 mm		
Side view / Periscope										
Cylindrical	dia. 4.75 mm	KHE-C01-2.2-2.0-K136	PMMA	Ultra: 200 mm HiPwr: 110 mm Std: 50 mm	0.5 mm	0.15 mm	2 m	min. 1 mm		only 1 mm Bend radius
Array										
Rectangular	3 x M2 x 0.5	KLE-A16-2.2-2.0-K109	PMMA	Ultra: 420 mm HiPwr: 240 mm Std: 100 mm	16 x 0.25 mm	0.05 mm	2 m	min. 25 mm		
Rectangular	3 x M3 x 0.5	KLE-A16-2.2-2.0-K110	PMMA	Ultra: 420 mm HiPwr: 240 mm Std: 100 mm	16 x 0.25 mm	0.05 mm	2 m	min. 25 mm		
Rectangular	3 x M3 x 0.5	KLE-A16-2.2-2.0-K111	PMMA	Ultra: 420 mm HiPwr: 240 mm Std: 100 mm	16 x 0.25 mm	0.05 mm	2 m	min. 25 mm		
Rectangular	2 x 3.2 mm	KLE-A32-2.2-2.0-K142	PMMA	Ultra: 140 mm HiPwr: 80 mm Std: 35 mm	32 x 0.25 mm		2 m	min. 25 mm		
High temperature resistance										
Cylindrical	dia. 3 mm	KHTE-C01-2.2-2.0-K118	PMMA	Ultra: 475 mm HiPwr: 270 mm Std: 115 mm	1 mm	0.35 mm	2 m	min. 25 mm		- 55°C ... + 115 °C

Release date: 2018-01-15 17:06 Date of issue: 2018-01-15 808703\_eng.xml

Head shape	Moun- ting	Model number	Core	Detection distance *	Fiber cross section	minimum Object size	Fiber optic length	Bend radius	Dimensions	Special features
<b>Sturdy design</b>										
Threaded	M3	LHE 00-1.1-1.0-14M3	glass	Ultra: 710 mm HiPwr: 420 mm Std: 195 mm	1.1 mm		1 m	4 mm static		-40°C ... + 180 °C
Threaded	M4 x 0.7 / M2.6	LHE 00-1.1-1.0-20M4	glass	Ultra: 710 mm HiPwr: 420 mm Std: 195 mm	1.1 mm		1 m	4 mm static		4 x high Detection range with Auxiliary lens K-LA01/ 8 x high Detection range with Auxiliary lens K-LA06 Side view / Periscope with K-LA02/ -40°C ... + 180 °C
Threaded	M6	LHE 00-1.1-1.0-G	glass	Ultra: 710 mm HiPwr: 420 mm Std: 195 mm	1.1 mm		1 m	4 mm static		-40°C ... + 180 °C
Cylindrical	dia. 1.5 mm	LHE 00-1.1-1.0-10C1.5	glass	Ultra: 710 mm HiPwr: 420 mm Std: 195 mm	1.1 mm		1 m	4 mm static		-40°C ... + 180 °C
Cylindrical	dia. 3 mm	LHE 00-1.1-1.0-15C3	glass	Ultra: 710 mm HiPwr: 420 mm Std: 195 mm	1.1 mm		1 m	4 mm static		-40°C ... + 180 °C
Right angle	Bar 3 mm	LHE 00-1.1-1.0-WC3	glass	Ultra: 710 mm HiPwr: 420 mm Std: 195 mm	1.1 mm		1 m	4 mm static		-40°C ... + 180 °C
Right angle	Bar 10 mm	LHE 00-1.1-1.0-K9	glass	Ultra: 710 mm HiPwr: 420 mm Std: 195 mm	1.1 mm		1 m	4 mm static		-40°C ... + 180 °C
<b>Special design</b>										
Rectangular	2 x 2.2 mm	KHE-A01-1.0-2.0-K138	PMMA	Ultra: 100 mm HiPwr: 60 mm Std: 25 mm	0.5 mm	0.05 mm	2 m	min. 1 mm		only 1 mm Bend radius
Slot	2 x 3.2 mm	KLE-C02-1.25-2.0-K134	PMMA	5 mm	2 x 0.25 m m		2 m	min. 10 mm		
Slot	2 x 3.2 mm	KLE-C02-1.25-2.0-K135	PMMA	10 mm	2 x 0.25 m m		2 m	min. 10 mm		



Std: Standard Mode, 160  $\mu$ s  
HiPwr: HighPower Mode, 500  $\mu$ s  
Ultra: Ultra Mode, 5 ms

### Selection table - diffuse mode fiber optic cable

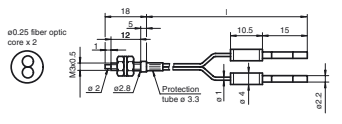
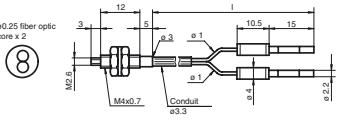
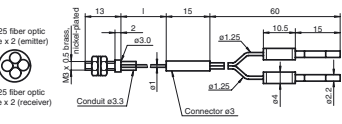
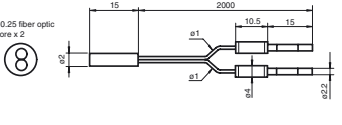
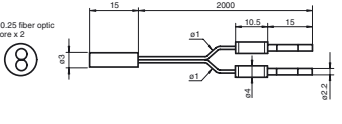
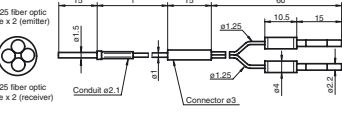
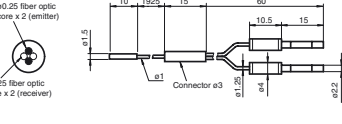
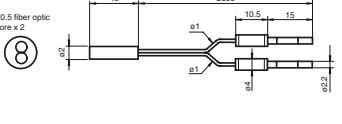
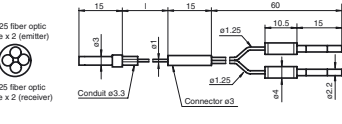
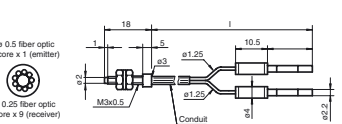
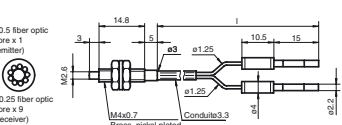

Head shape	Mounting	Model number	Core	Detection distance *	Fiber cross-section	Fiber optic length	Bend radius	Dimensions	Special features
<b>Highly precise</b>									
Threaded	M3 x 0.5	KLR-C02-1.0-2.0-K75	PMMA	Ultra: 12 mm HiPwr: 6 mm Std: 4 mm	2 x 0.25 m	2 m	min. 10 mm		
Threaded	M4 x 0.7	KLR-C02-1.0-2.0-K73	PMMA	Ultra: 12 mm HiPwr: 6 mm Std: 4 mm	2 x 0.25 mm	2 m	min. 10 mm		
Threaded	M3 x 0.5	KLR-C04-1.25-2.0-K78	PMMA	Ultra: 25 mm HiPwr: 18 mm Std: 8 mm	4 x 0.25 m	2 m	min. 15 mm		
Cylindrical	dia. 2.0 mm	KLR-C02-1.0-2.0-K91	PMMA	Ultra: 12 mm HiPwr: 6 mm Std: 4 mm	2 x 0.25 mm	2 m	min. 10 mm		
Cylindrical	dia. 3.0 mm	KLR-C02-1.0-2.0-K90	PMMA	Ultra: 12 mm HiPwr: 6 mm Std: 4 mm	2 x 0.25 mm	2 m	min. 10 mm		
Cylindrical	dia. 1.5 mm	KLR-C04-1.25-2.0-K80	PMMA	Ultra: 25 mm HiPwr: 18 mm Std: 8 mm	4 x 0.25 mm	2 m	min. 15 mm		
Cylindrical	dia. 1.5 mm	KLR-C04-1.0-2.0-K133	PMMA	Ultra: 25 mm HiPwr: 18 mm Std: 7 mm	4 x 0.25 mm	2 m	min. 15 mm		
Cylindrical	dia. 2.0 mm	KLR-C02-1.0-2.0-K87	PMMA	Ultra: 85 mm HiPwr: 52 mm Std: 25 mm	2 x 0.5 mm	2 m	min. 15 mm		
Cylindrical	dia. 3.0 mm	KLR-C04-1.25-2.0-K79	PMMA	Ultra: 25 mm HiPwr: 18 mm Std: 8 mm	4 x 0.25 mm	2 m	min. 15 mm		
<b>Coaxial</b>									
Threaded	M3 x 0.5	KLR-C09-1.25-2.0-K76	PMMA	Ultra: 100 mm HiPwr: 60 mm Std: 30 mm	1 x 0.5 mm Emitter 9 x 0.25 mm Receiver	2 m	min. 15 mm		only 0.5 mm light spot at 8 mm with auxiliary lens K-LA03
Threaded	M4 x 0.7 /M2.6	KLR-C09-1.25-2.0-K74	PMMA	Ultra: 100 mm HiPwr: 60 mm Std: 30 mm	1 x 0.5 mm Emitter 9 x 0.25 mm Receiver	2 m	min. 15 mm		only 0.7 mm light spot at 10 mm with auxiliary lens K-LA04/ 2 x high Detection range with Auxiliary lens K-LA01/ 3 x high Detection range with Auxiliary lens K-LA06

Release date: 2018-01-15 17:06 Date of issue: 2018-01-15 808703\_eng.xml

Refer to "General Notes Relating to Pepperl+Fuchs Product Information".

Pepperl+Fuchs Group  
www.pepperl-fuchs.com

USA: +1 330 486 0001  
fa-info@us.pepperl-fuchs.com

Germany: +49 621 776 4411  
fa-info@de.pepperl-fuchs.com

Singapore: +65 6779 9091  
fa-info@sg.pepperl-fuchs.com

Head shape	Mounting	Model number	Core	Detection distance *	Fiber cross-section	Fiber optic length	Bend radius	Dimensions	Special features
Threaded	M6 x 0.75	KLR-C16-2.2-2.0-K71	PMMA	Ultra: 300 mm HiPwr: 190 mm Std: 85 mm	1 x 1.0 mm Emitter 16 x 0.25 mm Receiver	2 m	min. 25 mm		
Cylindrical	dia. 1.0 mm	KLR-C06-1.25-2.0-K81	PMMA	Ultra: 70 mm HiPwr: 45 mm Std: 20 mm	1 x 0.25 mm Emitter 6 x 0.25 mm Receiver	2 m	min. 15 mm		
Cylindrical	dia. 3.0 mm	KLR-C09-1.25-2.0-K77	PMMA	Ultra: 110 mm HiPwr: 60 mm Std: 30 mm	1 x 0.5 mm Emitter 9 x 0.25 mm Receiver	2 m	min. 15 mm		
Cylindrical	dia. 5.0 mm	KLR-C16-2.2-2.0-K72	PMMA	Ultra: 300 mm HiPwr: 190 mm Std: 85 mm	1 x 1.0 mm Emitter 16 x 0.25 mm Receiver	2 m	min. 25 mm		
<b>Highly flexible</b>									
Threaded	M3	KHR-C02-1.0-2.0-K96	PMMA	Ultra: 40 mm HiPwr: 25 mm Std: 12 mm	2 x 0.5 mm	2 m	min. 1 mm		
Threaded	M4	KHR-C02-1.0-2.0-K95	PMMA	Ultra: 40 mm HiPwr: 25 mm Std: 12 mm	2 x 0.5 mm	2 m	min. 1 mm		
Threaded	M4	KHR-C02-1.3-2.0-K92	PMMA	Ultra: 210 mm HiPwr: 130 mm Std: 60 mm	2 x 1.0 mm	2 m	min. 2 mm		
Threaded	M6	KHR-C02-2.2-2.0-K94	PMMA	Ultra: 40 mm HiPwr: 25 mm Std: 12 mm	2 x 0.5 mm	2 m	min. 1 mm		
Cylindrical	dia. 3.0 mm	KHR-C02-1.3-2.0-K93	PMMA	Ultra: 200 mm HiPwr: 130 mm Std: 60 mm	2 x 1.0 mm	2 m	min. 2 mm		
<b>Flexible</b>									
Threaded	M6 x 0.75	KLR-C02-2.2-2.0-K70	PMMA	Ultra: 280 mm HiPwr: 180 mm Std: 80 mm	2 x 1.0 mm	2 m	min. 25 mm		
Cylindrical	dia. 3.0 mm	KLR-C02-1.3-2.0-K86	PMMA	Ultra: 280 mm HiPwr: 180 mm Std: 80 mm	2 x 1.0 mm	2 m	min. 25 mm		

Release date: 2018-01-15 17:06 Date of issue: 2018-01-15 808703\_eng.xml

Head shape	Mounting	Model number	Core	Detection distance *	Fiber cross-section	Fiber optic length	Bend radius	Dimensions	Special features
Cylindrical	dia. 5.0 mm	KLR-C02-2.2-2.0-K85	PMMA	Ultra: 280 mm HiPwr: 180 mm Std: 80 mm	2 x 1.0 mm	2 m	min. 25 mm		
Threaded	M3 x 0.5	KLR 00-1.0-2.0-K58	PMMA	Ultra: 68 mm HiPwr: 40 mm Std: 20 mm		2 m	min. 15 mm		
Threaded	M6	KLR 00-2.2-2.0-K57	PMMA	Ultra: 210 mm HiPwr: 130 mm Std: 60 mm		2 m	min. 15 mm		
<b>High detection range</b>									
Threaded		KLR-C02-2.2-2.0-K146	PMMA	Ultra: 460 mm HiPwr: 270 mm Std: 150 mm		2 m	mind. 40 mm		
Threaded		KLR-C10-1,25-2.0-K144	PMMA	Ultra: 95 mm HiPwr: 60 mm Std: 30 mm		2 m	mind. 15 mm		
<b>Side view / Periscope</b>									
Threaded	M6	KHR-C02-2.2-2.0-K131	PMMA	Ultra: 210 mm HiPwr: 135 mm Std: 60 mm	2 x 1.0 mm	2 m	min. 2 mm		only 2 mm Bend radius
Threaded	dia. 5.0 mm	KHR-C02-1.0-2.0-K132	PMMA	Ultra: 52 mm HiPwr: 33 mm Std: 15 mm	2 x 0.5 mm	2 m	min. 1 mm		only 1 mm Bend radius
<b>Array</b>									
Rectangular	3 x M2 x 0.5	KLR-A18-1.3-2.0-K82	PMMA	Ultra: 86 mm HiPwr: 55 mm Std: 25 mm	18 x 0.25 m m	2 m	min. 25 mm		
Rectangular	3 x M3 x 0.5	KLR-A32-2.2-2.0-K83	PMMA	Ultra: 120 mm HiPwr: 78 mm Std: 35 mm	10.85 mm	2 m	min. 25 mm		
Rectangular	2 x 3.2 m m	KLR-A32-2.2-2.0-K141	PMMA	Ultra: 120 mm HiPwr: 78 mm Std: 35 mm	16 x 0.25 mm	2 m	mind. 25 mm		
<b>High temperature resistance</b>									
Threaded	M6	KHTR-C02-2.2-2.0-K88	PMMA	Ultra: 280 mm HiPwr: 180 mm Std: 80 mm	2 x 1.0 mm	2 m	min. 25 mm		-55°C ... +115°C

Release date: 2018-01-15 17:06 Date of issue: 2018-01-15 808703\_eng.xml

Refer to "General Notes Relating to Pepperl+Fuchs Product Information".

Pepperl+Fuchs Group  
www.pepperl-fuchs.com

USA: +1 330 486 0001  
fa-info@us.pepperl-fuchs.com

Germany: +49 621 776 4411  
fa-info@de.pepperl-fuchs.com

Singapore: +65 6779 9091  
fa-info@sg.pepperl-fuchs.com

Head shape	Mounting	Model number	Core	Detection distance *	Fiber cross-section	Fiber optic length	Bend radius	Dimensions	Special features
Cylindrical	dia. 5.0 mm	KHTR-C02-2.2-2.0-K89	PMMA	Ultra: 280 mm HiPwr: 180 mm Std: 80 mm	2 x 1.0 mm	2 m	min. 25 mm		- 55°C ... + 115°C
<b>Sturdy design</b>									
Threaded	M3 x 0.5	LHR 00-0.8-1.0-14M3	glass	Ultra: 195 mm HiPwr: 100 mm Std: 40 mm	0.8 mm	1 m	4 mm static		- 40°C ... + 180°C
Threaded	M4 x 0.7	LHR 00-0.8-1.0-20M4	glass	Ultra: 195 mm HiPwr: 100 mm Std: 40 mm	0.8 mm	1 m	4 mm static		- 40°C ... + 180°C
Threaded	M6	LHR 00-1.1-1.0-G	glass	Ultra: 230 mm HiPwr: 156 mm Std: 70 mm	1.1 mm	1 m	4 mm static		- 40°C ... + 180°C
Cylindrical	dia. 3 mm	LHR 00-1.1-1.0-Z1	glass	Ultra: 230 mm HiPwr: 156 mm Std: 70 mm	1.1 mm	1 m	4 mm static		- 40°C ... + 180°C
Cylindrical	dia. 4.5 mm	LHR 00-1.1-1.0-K1	glass	Ultra: 230 mm HiPwr: 156 mm Std: 70 mm	1.1 mm	1 m	4 mm static		- 40°C ... + 180°C
Right angle	10 mm Bar	LHR 00-1.1-1.0-K9	glass	Ultra: 230 mm HiPwr: 156 mm Std: 70 mm	1.1 mm	1 m	4 mm static		- 40°C ... + 180°C
<b>Special design</b>									
Rectangular		KHR-C02-1.0-2.0-K129	PMMA	5 ~ 10 mm	2 x 0.5 mm	2 m	min. 1 mm		<b>crossed beam to background blanking</b> <b>only 1 mm Bend radius</b>
Rectangular		KLR-C02-1.3-2.0-K130	PMMA	1 ~ 8 mm	2 x 1.0 mm	2 m	min. 25 mm		<b>crossed beam to background blanking</b>
Rectangular	3 x M3 x 0.5	KHR-A02-2.2-2.0-K127	PMMA	Ultra: 175 mm HiPwr: 112 mm Std: 50 mm	2 x 1.0 mm	2 m	min. 2 mm		<b>only 2 mm Bend radius</b>
Rectangular		KLR-C02-1.25-2.0-K128	PMMA	4-26 mm	2 x 0.5 mm	2 m	min. 15 mm		<b>Level measurement</b>

Release date: 2018-01-15 17:06 Date of issue: 2018-01-15 808703\_eng.xml

Head shape	Mounting	Model number	Core	Detection distance *	Fiber cross-section	Fiber optic length	Bend radius	Dimensions	Special features
Cylindrical		KLR-C02-1,25-2,0-K147	PMMA			2 m	mind. 40 mm		Fluid detection

	<p>Std: Standard Mode, 160 <math>\mu</math>s                      HiPwr: HighPower Mode, 500 <math>\mu</math>s                      Ultra: Ultra Mode, 5 ms</p>
--	---

Release date: 2018-01-15 17:06 Date of issue: 2018-01-15 808703\_eng.xml

Refer to "General Notes Relating to Pepperl+Fuchs Product Information".

Pepperl+Fuchs Group  
 www.pepperl-fuchs.com

USA: +1 330 486 0001  
 fa-info@us.pepperl-fuchs.com

Germany: +49 621 776 4411  
 fa-info@de.pepperl-fuchs.com

Singapore: +65 6779 9091  
 fa-info@sg.pepperl-fuchs.com