

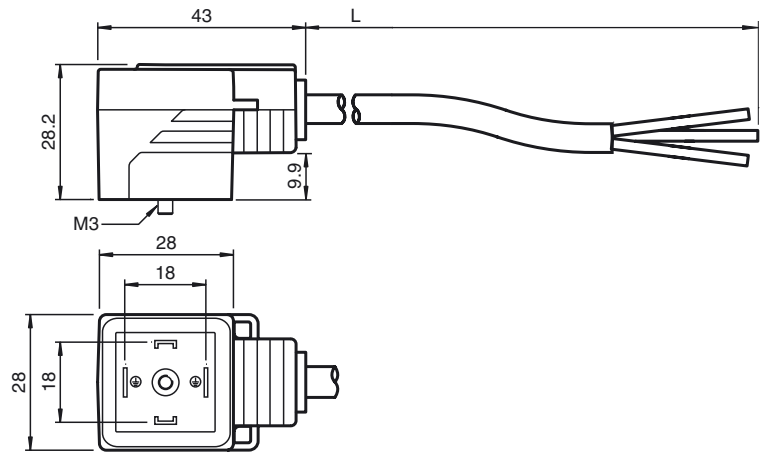

Dimensions



Model Number

VMA-2+P-10M-PUR

Valve connector, Form A, 2+PE, PUR cable

Features

- Valve connector according EN 175301-803 A/ISO 4400 (previously DIN 43650)
- Moulded seal
- Suitable for drag chains
- freely selectable cable models due to bridged protective earth
- Flame resistant cable
- Halogen-free

Technical data

General specifications

Number of pins 2 + PE

Electrical specifications

Operating voltage U_B 250 V AC/DC
 Operating current I_B max. 10 A
 Volume resistance < 10 mΩ

Ambient conditions

Ambient temperature Body: -25 ... 80 °C (-13 ... 176 °F)
 cable, flexing: -20 ... 80 °C (-4 ... 176 °F)
 cable, fixed: -40 ... 80 °C (-40 ... 176 °F)

Pollution Degree 3

Mechanical specifications

Degree of protection IP65/IP67
 Connection Valve connector Form A

Material

Contacts CuSn
 Contact surface Sn
 Body TPU, black
 Cable PUR
 Core insulation PP
 Cable
 Sheath diameter Ø 4.5 mm
 Bending radius > 50 mm
 > 22.5 mm, fixed
 Color dark grey (RAL 7021)
 Cores (2 + 1) x 0.5 mm²; 20 AWG
 Conductor construction 28 x 0.15 mm Ø
 Length L 10 m

Drag chain suitability

Drag chain cycles ≥ 15000000
 Motion velocity ≤ 5 m/s
 Traverse distance 0.9 m
 Acceleration ≤ 30 m/s²

Electrical connection

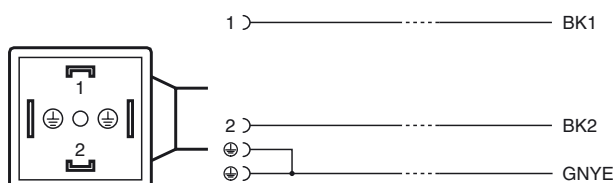

Release date: 2015-12-14 15:39 Date of issue: 2015-12-14 456827_eng.xml