



Model Number

V1-G-T-BK1,5M-PUR-A-V1-G

Y connecting cable, M12 to 2xM12, 4-pin, PUR cable

Features

- Simple assembling of 2 signals to one M12 plug-in station
- Improved resistance to weld slag
- Immunity to vibration, with mechanical latching
- Suitable for drag chains
- Suitable for robotic applications / torsion resistant
- Flame resistant cable
- Halogen-free
- Resistant to microbes and hydrolysis
- Free from substances that impair paint wetting

Dimensions

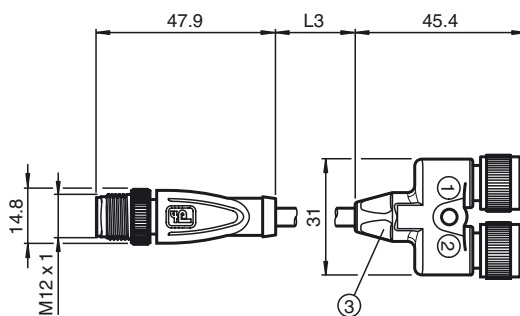

Technical data

General specifications

Number of pins	4
Connection 1	socket
Construction type 1	straight
Threading 1	M12
Connection 2	socket
Construction type 2	straight
Threading 2	M12
Connection 3	Male connector
Construction type 3	straight
Threading 3	M12
UL File Number	E231213

Electrical specifications

Operating voltage	U_B	max. 30 V AC/DC
Operating current	I_B	max. 4 A
Volume resistance		$\leq 5 \text{ m}\Omega$
Surge protection		overvoltage category III

Ambient conditions

Ambient temperature	Body: -40 ... 90 °C (-40 ... 194 °F) cable, fixed: -40 ... 80 °C (-40 ... 176 °F) cable, flexing: -25 ... 80 °C (-13 ... 176 °F)
Pollution degree	3

Mechanical specifications

Contact elements	spring-loaded contact socket
Pin diameter	1 mm
Degree of protection	IP67
Connection	1 x M12 connector, straight 2 x M12 straight sockets

Material

Contacts	CuSn / Au
Contact surface	Au
Body	TPU, black
Cable	PUR
Slotted nut	Diecast zinc
Sleeve connector	Diecast zinc
Core insulation	PP
Cable	extra-fine wire, flexible
Sheath diameter	$\varnothing 4.3 \text{ mm}$
Bending radius	> 10 x cable diameter, moving > 5 x cable diameter, fixed
Color	black
Cores	4 x 0.34 mm ²
Conductor construction	42 x 0.1 mm \varnothing
Length	L L3 = 1.5 m

Electrical connection

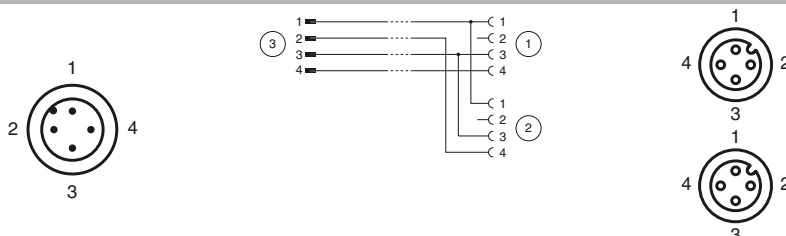

Drag chain suitability

Drag chain cycles	≥ 5000000 (at max. 60 °C)
Motion velocity	≤ 3.3 m/s
Traverse distance	5 m horizontal
Acceleration	≤ 5 m/s ²
Torsion cycles	≥ 1000000 (at max. 60 °C)
Torsional stress	± 180 °/m

Flammability

Contact carrier	94 HB
Housing	94 V-2
Cable	FT2

Compliance with standards and directives

Standard conformity

Degree of protection	EN 60529:2000
Standards	IEC 61076-2-101:2008
Flammability	Grip: UL 94 Cable: UL 758 / UL 1581
Halogen-free	IEC 60754-1:1994/DIN VDE 0472-815

Approvals and certificates

UL approval	UL Recognized General purpose
-------------	-------------------------------