

Model Number

V15-G-S-10M-T-03M-PUR-A-V1-C1

Y-splitter cordset for transmission channel C1

Features

- Immunity to vibration, with mechanical latching
- Suitable for drag chains
- Suitable for robotic applications / torsion resistant
- Flame resistant cable
- Halogen-free
- Resistant to microbes and hydrolysis
- Suitable for use with the MLC 500 light curtain

Dimensions

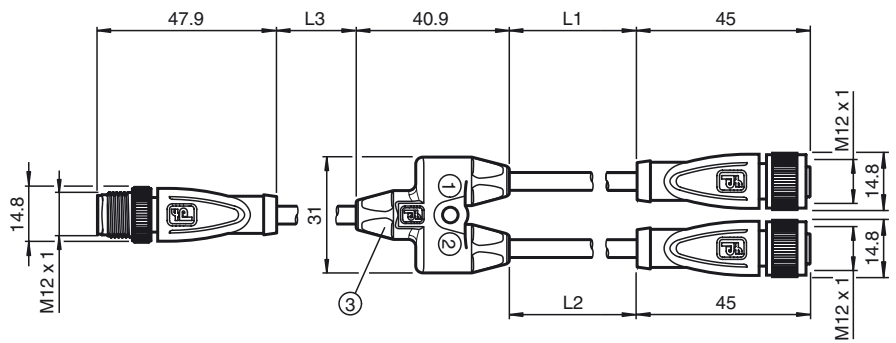

Technical data

General specifications

Number of pins 5

Electrical specifications

Operating voltage U_B max. 30 V AC/DC

Operating current I_B max. 4 A

Volume resistance $\leq 5 \text{ m}\Omega$

Surge protection overvoltage category III

Ambient conditions

Ambient temperature Body: -40 ... 90 °C (-40 ... 194 °F)
cable, fixed: -40 ... 80 °C (-40 ... 176 °F)
cable, flexing: -25 ... 80 °C (-13 ... 176 °F)

Pollution degree 3

Mechanical specifications

Contact elements spring-loaded contact socket

Pin diameter 1 mm

Degree of protection IP67

Connection 1 x M12 connector, straight
2 x M12 straight sockets

Material

Contacts CuSn

Contact surface Au

Body TPU, yellow
TPU, black

Cable PUR

Slotted nut Diecast zinc

Core insulation PP

Cable extra-fine wire, flexible

Sheath diameter $\varnothing 4.7 \text{ mm}$

Bending radius $> 10 \times$ cable diameter, moving
 $> 5 \times$ cable diameter, fixed

Color yellow

Number of cores 5

Core cross-section 0.34 mm^2

Conductor construction $42 \times 0.1 \text{ mm } \varnothing$

Length L L1 = 10 m
L2 = 10 m
L3 = 3 m

Drag chain suitability

Drag chain cycles ≥ 5000000 (at max. 60 °C)

Motion velocity $\leq 3.3 \text{ m/s}$

Traverse distance 5 m horizontal

Acceleration $\leq 5 \text{ m/s}^2$

Torsion cycles ≥ 1000000 (at max. 60 °C)

Torsional stress $\pm 180 \text{ }^\circ/\text{m}$

Electrical connection

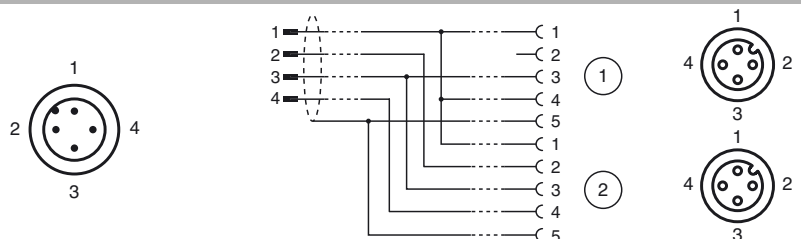

Release date: 2016-06-20 12:01 Date of issue: 2016-08-01 292374_eng.xml

Refer to "General Notes Relating to Pepperl+Fuchs Product Information".

Pepperl+Fuchs Group
www.pepperl-fuchs.com

USA: +1 330 486 0001
fa-info@us.pepperl-fuchs.com

Germany: +49 621 776 4411
fa-info@de.pepperl-fuchs.com

Singapore: +65 6779 9091
fa-info@sg.pepperl-fuchs.com

Flammability	
Contact carrier	94 HB
Housing	94 V-2
Cable	FT2
Note	Socket 1 = transmitter Socket 2 = receiver
Compliance with standards and directives	
Standard conformity	
Degree of protection	EN 60529:2000
Standards	IEC 61076-2-101:2008
Flammability	Body: UL 94 Line: UL 1581 Section 1061; IEC 60332-1-2:2004
Halogen-free	IEC 60754-1:1994

Release date: 2016-06-20 12:01 Date of issue: 2016-08-01 292374_eng.xml