



Model Number

V3-WM-BK1,5M-PUR-U-TV1-G

Y connecting cable, M12 to 2 x M8, 3-pin, PUR cable

Features

- Raw cable with cURus approval
- Simple assembling of 2 signals to one M12 plug-in station
- Flame resistant cable
- Resistant to microbes and hydrolysis
- Immunity to vibration
- Suitable for drag chains
- Halogen-free
- Free from substances that impair paint wetting

Dimensions

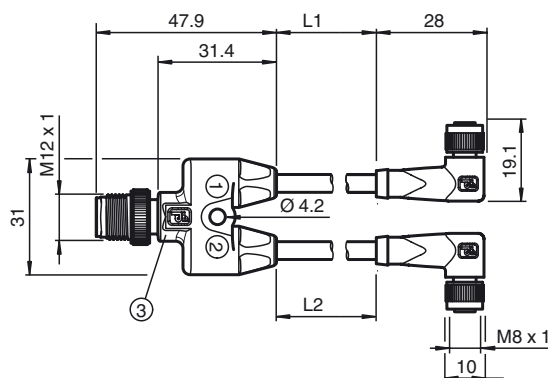

Technical data

General specifications

Number of pins	3
Connection 1	socket
Construction type 1	right angle
Threading 1	M8
Connection 2	socket
Construction type 2	right angle
Threading 2	M8
Connection 3	Male connector
Construction type 3	straight
Threading 3	M12
UL File Number	E231213

Electrical specifications

Operating voltage	U_B	48 V AC 60 V DC
Operating current	I_B	max. 4 A
Volume resistance		< 5 m Ω

Ambient conditions

Ambient temperature	-5 ... 80 °C (23 ... 176 °F) active -25 ... 80 °C (-13 ... 176 °F) static
Pollution degree	3

Mechanical specifications

Degree of protection	IP65 / IP68 / IP69K
Connection	1 x M12 connector, straight 2 x M8 socket, angled
Cable code	Li 9Y 11Y 3 x 0.34
Material	
Contacts	CuSn
Contact surface	Ni/Au
Connector	TPU
Body	TPU, black
Cable	PUR
Slotted nut	Zinc die-casting, nickel-plated
Sleeve connector	Zinc die-casting, nickel-plated
Core insulation	PP
Cable	extra-fine wire, flexible
Sheath diameter	Ø 4.3 mm
Bending radius	> 10 x cable diameter, moving > 5 x cable diameter, fixed
Color	black
Number of cores	3
Core cross-section	0.34 mm ²
Conductor construction	42 x 0.1 mm Ø
Length	L 1.5 m

Electrical connection

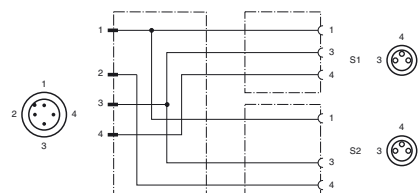

Drag chain suitability

Drag chain cycles	≥ 5000000
Motion velocity	≤ 3.3 m/s
Acceleration	≤ 5 m/s ²
Torsional stress	± 180 °/m

Flammability

Cable	FT2
-------	-----

Compliance with standards and directives

Standard conformity

Flammability	Body: UL 94 Line: UL 1581 Section 1061; IEC 60332-1-2:2004
Halogen-free	IEC 60754-1:1994

Approvals and certificates

UL approval	UL Recognized General purpose
-------------	-------------------------------

Maximum permissible operating voltage ≤ 60 V

Maximum permissible ambient temperature ≤ 80 °C (≤ 176 °F)