



## Inclination sensor INY030D-F99-B20-V15

- E1-Type approval
- High shock resistance
- Extended temperature range  
-40 ... +85 °C
- Measuring range -15° ... +15°
- CAN bus with SAE J1939 protocol



### Dimensions

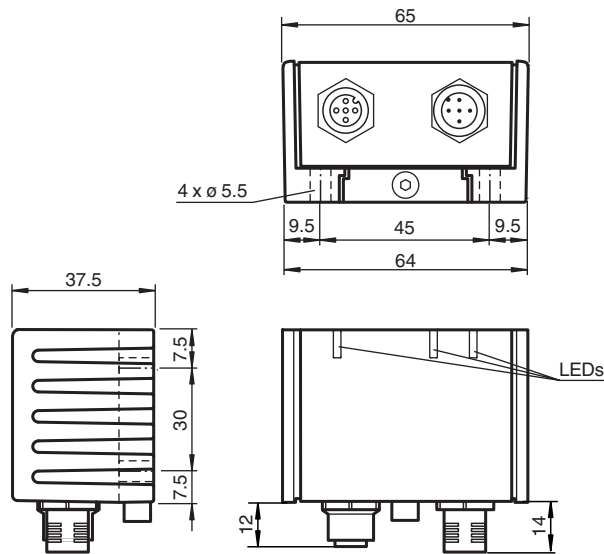

### Technical Data

#### General specifications

Type	Inclination sensor, 2-axis
Measurement range	-15 ... 15 °
Absolute accuracy	≤ ± 0.2 °
Response delay	≤ 25 ms
Resolution	≤ 0.01 °
Repeat accuracy	≤ ± 0.02 °
Temperature influence	≤ 0.004 °/K

#### Functional safety related parameters

Release date: 2020-04-24 Date of issue: 2020-06-03 Filename: 241680\_eng.pdf

Refer to "General Notes Relating to Pepperl+Fuchs Product Information".

Pepperl+Fuchs Group  
www.pepperl-fuchs.com

USA: +1 330 486 0001  
fa-info@us.pepperl-fuchs.com

Germany: +49 621 776 1111  
fa-info@de.pepperl-fuchs.com

Singapore: +65 6779 9091  
fa-info@sg.pepperl-fuchs.com

 PEPPERL+FUCHS

## Technical Data

MTTF <sub>d</sub>	650 a	
Mission Time (T <sub>M</sub> )	20 a	
Diagnostic Coverage (DC)	0 %	
<b>Indicators/operating means</b>		
Operation indicator	LED, green	
Status indicator	LED, yellow	
Error indicator	LED, red	
<b>Electrical specifications</b>		
Operating voltage	U <sub>B</sub>	5 ... 30 V DC
No-load supply current	I <sub>0</sub>	≤ 100 mA
Power consumption	P <sub>0</sub>	≤ 0.7 W
<b>Interface</b>		
Interface type	J1939	
Data output code	binary code	
Transfer rate	10 ... 1000 kBit/s , programmable	
Node ID	0 ... 253 , programmable	
Termination	external	
Cycle time	programmable	
SLOT Range	-15 ... 15 °	
SLOT Offset	180 °	
<b>Compliance with standards and directives</b>		
Standard conformity		
Shock and impact resistance	100 g according to DIN EN 60068-2-27	
Standards	EN 60947-5-2:2007 IEC 60947-5-2:2007	
<b>Approvals and certificates</b>		
UL approval	cULus Listed, Class 2 Power Source	
E1 Type approval	10R-04	
<b>Ambient conditions</b>		
Ambient temperature	-40 ... 85 °C (-40 ... 185 °F)	
Storage temperature	-40 ... 85 °C (-40 ... 185 °F)	
<b>Mechanical specifications</b>		
Connection type	5-pin, M12 x 1 connector 5-pin, M12 x 1 socket internal bridged	
Housing material	PA	
Degree of protection	IP68 / IP69K	
Mass	240 g	
<b>Factory settings</b>		
Node ID	128	
Transfer rate	250 kBit/s	

## Connection

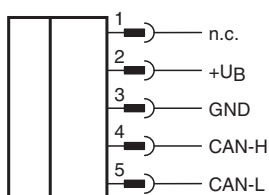

**Connection Assignment**

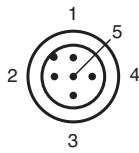

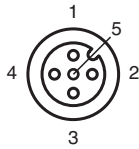

**Connection Assignment**



Wire colors in accordance with EN 60947-5-2

1	BN	(brown)
2	WH	(white)
3	BU	(blue)
4	BK	(black)
5	GY	(gray)

**Accessories**

	<b>V15S-T-CAN/DN-V15</b>	Y-Splitter, M12 socket on M12 connector/socket
	<b>ICZ-TR-CAN/DN-V15</b>	Terminal resistor for DeviceNet, CANopen

Release date: 2020-04-24 Date of issue: 2020-06-03 Filename: 241680\_eng.pdf

Refer to "General Notes Relating to Pepperl+Fuchs Product Information".

## Mounting

### Sensor Orientation

In the default setting the zero position of the sensor is reached, when the sensor is mounted on a horizontal plane and electrical connection faces sideways.

## Mounting

### Mounting of the sensor

Sensors from the -F99 series consist of a sensor module and accompanying cast aluminum housing. Select a horizontal flat surface with minimum dimensions of 70 mm x 50 mm to mount the sensor.

Mount the sensor as follows:

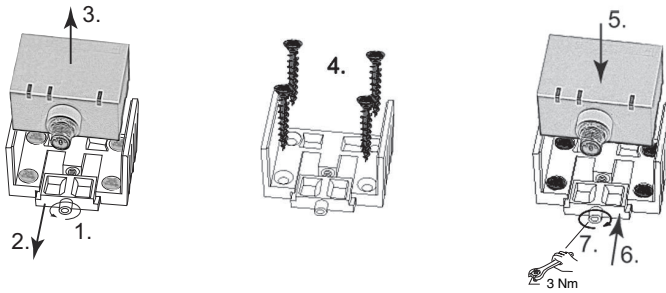

1. Loosen the central screw under the sensor connection.
  2. Slide back the clamping element until you are able to remove the sensor module from the housing.
  3. Remove the sensor module from the housing
  4. Position the housing at the required mounting location and secure using four countersunk screws. Make sure that the heads of the screws do not protrude.
  5. Place the sensor module in the housing.
  6. Slide the clamping element flush into the housing. Check that the sensor element is seated correctly.
  7. Finally tighten the central screw.
- The sensor is now mounted correctly.

## Technical Features

### EMC Properties

Interference immunity in accordance with  
 DIN ISO 11452-2: 100 V/m  
 Frequency band 20 MHz up to 280 MHz and 295 MHz up to 2 GHz  
 Mains-borne interference in accordance with ISO 7637-2:

Pulse	1	2	2	3	3	4	5
		a	b	a	b		
Severity level	I	I	I	I	I	I	I
	I	I	I	I	I	I	V
	I	I	I	I	I	I	
Failure criterion	C	A	C	A	A	C	A
EN 61000-4-2:	CD: 8 kV		AD: 15 kV				
	/						
Severity level	IV		IV				
EN 61000-4-3:	30 V/m (80...2500 MHz)						
Severity level	IV						
EN 61000-4-4:	2 kV						
Severity level	III						
EN 61000-4-6:	10 V (0.01...80 MHz)						
Severity level	III						
EN 55011:	Klasse A						

Release date: 2020-04-24 Date of issue: 2020-06-03 Filename: 241680\_eng.pdf