



**Model number**

**WCS2B-LS121**

Reading head, RS-485 interface, without RS-485 termination resistor

**Features**

- RS-485 interface
- Non-contact, absolute position encoder
- Automatic detection of dirt accumulation

**Accessories**

**WCS-MP1**

Mounting plate for reading heads WCS2 and WCS3

**WCS2-PL2**

Transparent protective case and seal for WCS2 reader

**Note**

with RS-485 interface

**Dimensions**

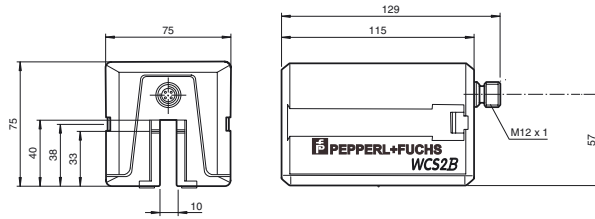

**Mounting plate**

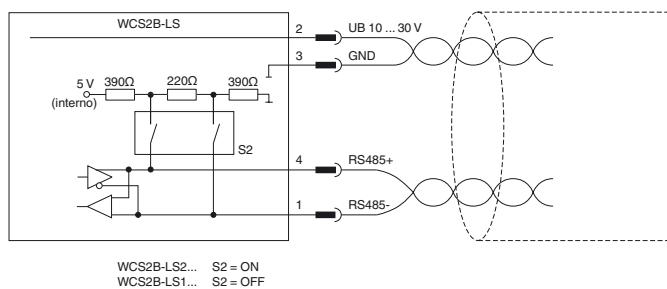
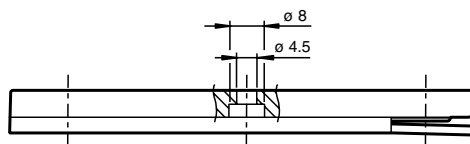
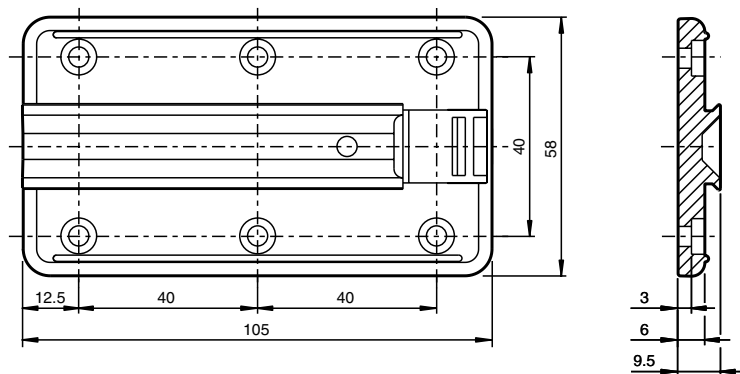

**Technical data**

**General specifications**

Passage speed	v	≤ 12.5 m/s
Measuring range		max. 327 m
Free tolerances to code rail		horizontal: 10 mm ( ± 5 mm ) vertical: 10 mm ( ± 5 mm )
Resolution		± 0.42 mm (1,200 positions/m)

**Functional safety related parameters**

MTTF <sub>d</sub>	66 a
Mission Time (T <sub>M</sub> )	10 a
Diagnostic Coverage (DC)	0 %

**Electrical specifications**

Operating voltage	U <sub>B</sub>	10 ... 30 V DC
Power consumption	P <sub>0</sub>	2 VA

Release date: 2019-08-21 14:12 Date of issue: 2019-08-21 200779-0003\_eng.xml

**Interface**

Interface type	RS 485 interface
Data output code	binary code
Protocol	1 , 2
Transfer rate	62.5 MBit/s
Termination	without RS 485 termination

**Standard conformity**

Emitted interference	DIN EN 61000-6-4
Noise immunity	DIN EN 61000-6-2
Shock resistance	DIN EN 60068-2-27, half sine 30 g, 18 ms
Vibration resistance	DIN EN 60068-2-6, sine, 5 g, 10 - 2000 Hz, 10 cycles

**Ambient conditions**

Operating temperature	0 ... 60 °C (32 ... 140 °F)
Storage temperature	-40 ... 85 °C (-40 ... 185 °F)
Relative humidity	90 % , noncondensing

**Mechanical specifications**

Connection type	5-pin, M12 x 1 connector
Degree of protection	IP54
Material	
Housing	ABS , Polycarbonate , Polyamide (PA)
Mass	500 g

**General information**

Ordering information	Mounting plate included with delivery
----------------------	---------------------------------------