



Reader with protective housing

WCS3B-LS610D-OM

- PROFINET interface
- Non-contact, absolute position encoder
- Automatic detection of dirt accumulation
- Output of position and speed
- For outdoor use
- Integrated display module

Reader with protective housing and PROFINET interface



Dimensions

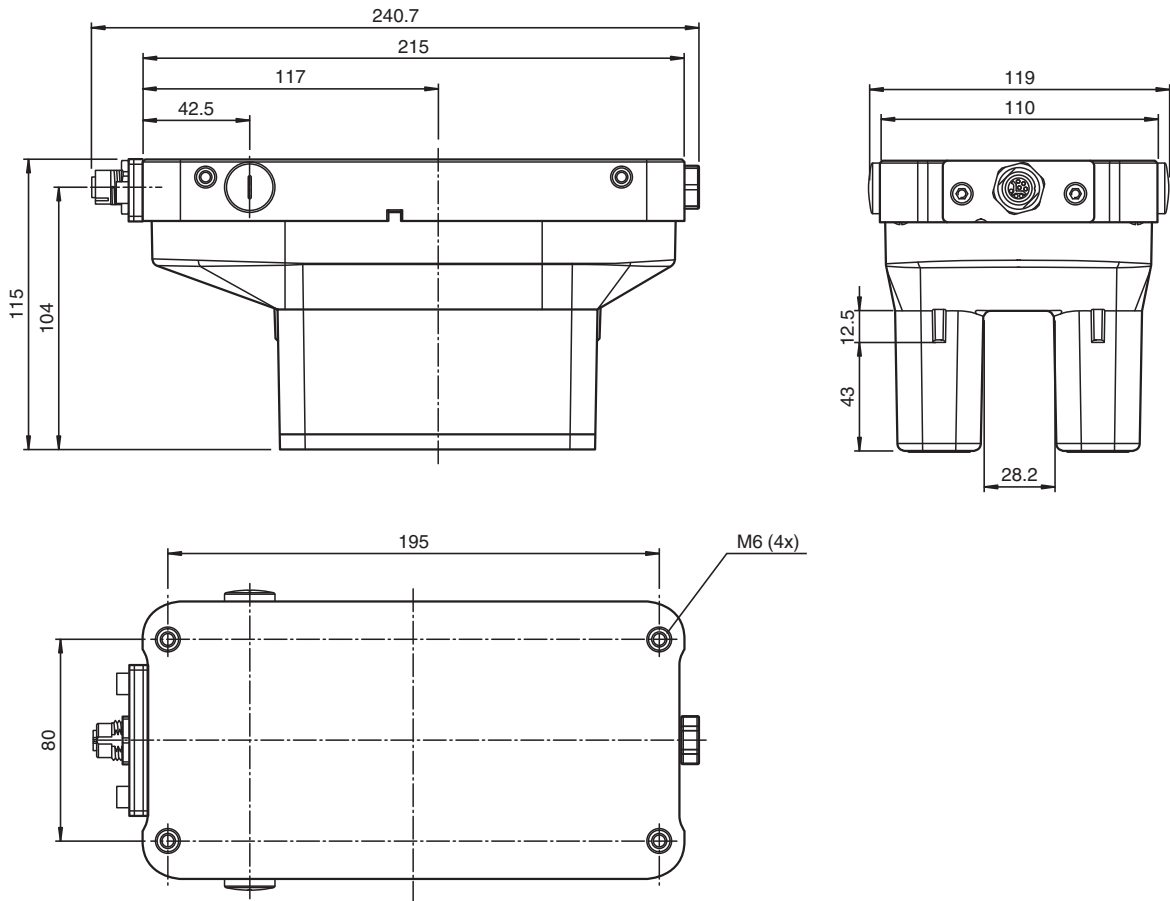

Technical Data

General specifications

Passage speed	v	≤ 12.5 m/s
Measuring range		max. 314.5 m

Release date: 2021-01-27 Date of issue: 2021-01-27 Filename: 312678_eng.pdf

Refer to "General Notes Relating to Pepperl+Fuchs Product Information".

Pepperl+Fuchs Group
www.pepperl-fuchs.com

USA: +1 330 486 0001
fa-info@us.pepperl-fuchs.com

Germany: +49 621 776 1111
fa-info@de.pepperl-fuchs.com

Singapore: +65 6779 9091
fa-info@sg.pepperl-fuchs.com

PF PEPPERL+FUCHS

Technical Data

Free tolerances to code rail	horizontal: 28 mm (± 14 mm) vertical: 25.5 mm (+11.5 mm/-14 mm)	
Resolution	± 0.4 mm (1,250 positions/m)	
Functional safety related parameters		
MTTF _d	181 a	
Mission Time (T _M)	20 a	
Diagnostic Coverage (DC)	0 %	
Indicators/operating means		
Display	Display module, 6-digit , adaptable to installation position	
LED green	PROFINET link To: PROFINET connection OK	
LED yellow	PROFINET RX/TX Flashing: data transfer	
LED red	PROFINET communication To: communication error	
LED red/green	Status indication Green: code rail detected, normal function Red: system error Flashing red: no code rail detected	
Electrical specifications		
Operating voltage	U _B	10 ... 30 V DC
Power consumption	P ₀	6 W
Interface		
Interface type	100 BASE-TX	
Data output code	binary code	
Protocol	PROFINET IO Real-Time (RT) Conformance class B	
Transfer rate	100 MBit/s	
Standard conformity		
Emitted interference	EN 61000-6-4:2007+A1:2011	
Noise immunity	EN 61000-6-2:2005	
Shock resistance	EN 60068-2-27:2009	
Vibration resistance	EN 60068-2-6:2008	
Approvals and certificates		
CSA approval	cCSAus Certified, General Purpose Class 2 power source	
CCC approval	CCC approval / marking not required for products rated ≤36 V	
Ambient conditions		
Operating temperature	0 ... 60 °C (32 ... 140 °F)	
Storage temperature	-40 ... 85 °C (-40 ... 185 °F)	
Mechanical specifications		
Connection type	8-pin, M12 x 1 connector socket, Y-coded	
Degree of protection	IP67 / IP69	
Material		
Housing	PET , PC (Polycarbonate)	
Mass	1000 g	
Note	The reader must not be operated without the protective housing!	

Release date: 2021-01-27 Date of issue: 2021-01-27 Filename: 312678_eng.pdf

Refer to "General Notes Relating to Pepperl+Fuchs Product Information".







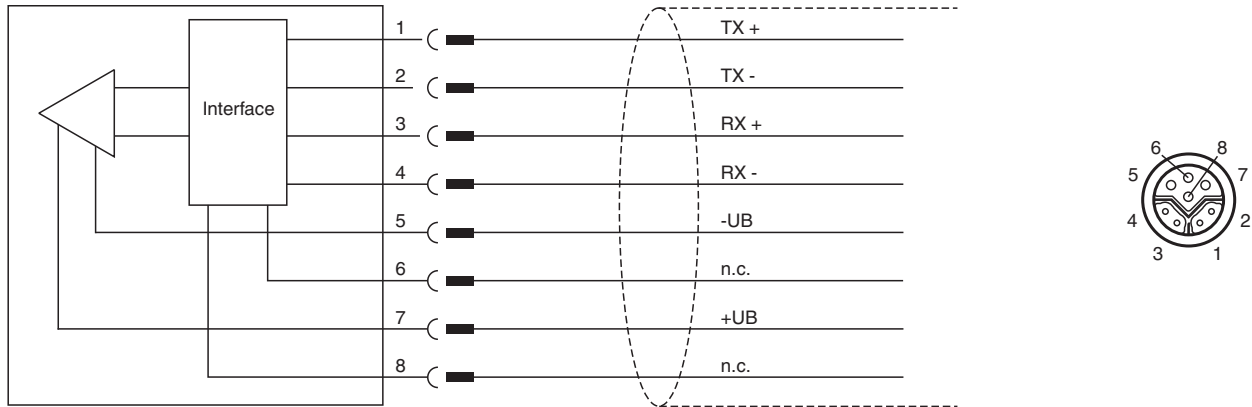



Pepperl+Fuchs Group
www.pepperl-fuchs.comUSA: +1 330 486 0001
fa-info@us.pepperl-fuchs.comGermany: +49 621 776 1111
fa-info@de.pepperl-fuchs.comSingapore: +65 6779 9091
fa-info@sg.pepperl-fuchs.com

PEPPERL+FUCHS

Connection



Accessories

	V19SY-G-BK2M-PUR-ABG	Male single-ended cordset, M12, 8-pin, Y encryption, PUR cable, shielded
	V19SY-G-BK5M-PUR-ABG	Male single-ended cordset, M12, 8-pin, Y encryption, PUR cable, shielded
	V19SY-G-BK10M-PUR-ABG	Male single-ended cordset, M12, 8-pin, Y encryption, PUR cable, shielded
	V45-G	Field-attachable male connector
	WCS3B-OPC	Outdoor protective cover for WCS3B reader
	V45-GP	Field-attachable "Push-Pull" connector
	V15S-W-ABG-PG9	Cable connector, M12, 5-pin, shielded, non pre-wired
	V15S-G-ABG-PG9	Cable connector, M12, 5-pin, shielded, non pre-wired
	WCS3B-OBP	Stopping plugs For WCS3B-OP* housing
	V1SD-G-5M-PUR-ABG-V45-G	Connection cable, M12 to RJ-45, PUR cable 4-pin, CAT5e
	V19SY-Y-V1D/V1S	Y-Splitter, M12 plug Y-coded to M12 plug A-coded/socket D-coded

Release date: 2021-01-27 Date of issue: 2021-01-27 Filename: 312678_eng.pdf