



Model number

WCS2B-LS246

Read head, RS-485 interface, with RS-485 termination resistor

Features

- RS-485 interface
- Non-contact, absolute position encoder
- Automatic detection of dirt accumulation

Accessories

WCS-MP1

Mounting plate for reading heads WCS2 and WCS3

WCS2-PL2

Transparent protective case and seal for WCS2 reader

Note

with RS-485 interface

Dimensions

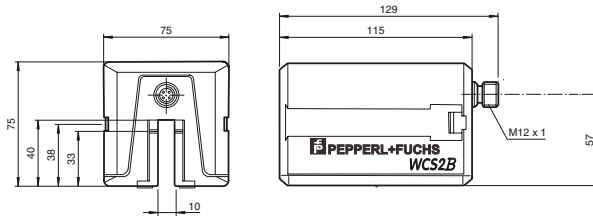

Mounting plate

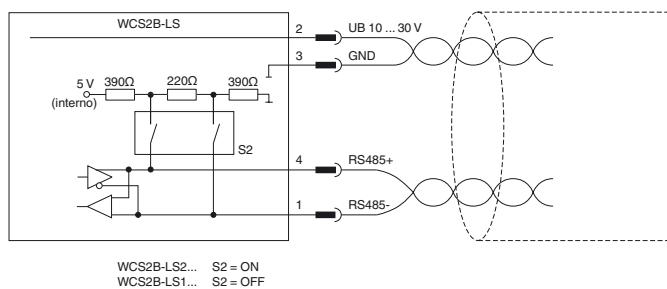
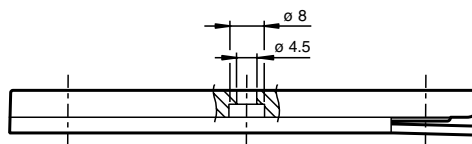
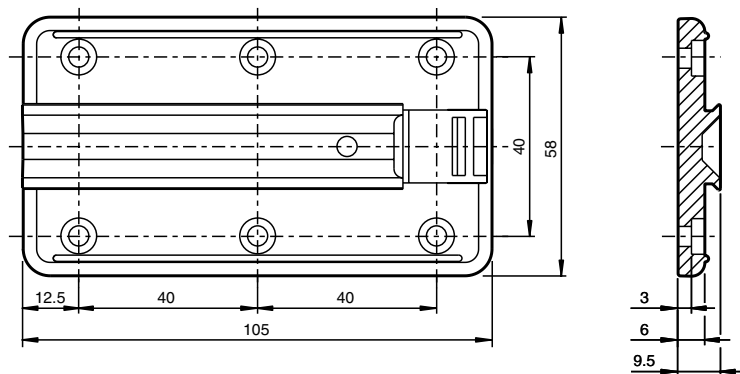

Technical data

General specifications

Passage speed	v	≤ 12.5 m/s
Measuring range		max. 327 m
Free tolerances to code rail		horizontal: 10 mm (± 5 mm) vertical: 10 mm (± 5 mm)
Resolution		± 0.42 mm (1,200 positions/m)

Functional safety related parameters

MTTF _d	66 a
Mission Time (T _M)	10 a
Diagnostic Coverage (DC)	0 %

Electrical specifications

Operating voltage	U _B	10 ... 30 V DC
Power consumption	P ₀	2 VA

Release date: 2019-08-21 14:12 Date of issue: 2019-08-21 200779-0010_eng.xml

Refer to "General Notes Relating to Pepperl+Fuchs Product Information".

Interface

Interface type	RS 485 interface
Data output code	binary code
Protocol	3 , with Parity (9 Bit/Byte)
Transfer rate	19.2 kBit/s
Termination	with RS 485 termination

Standard conformity

Emitted interference	DIN EN 61000-6-4
Noise immunity	DIN EN 61000-6-2
Shock resistance	DIN EN 60068-2-27, half sine 30 g, 18 ms
Vibration resistance	DIN EN 60068-2-6, sine, 5 g, 10 - 2000 Hz, 10 cycles

Ambient conditions

Operating temperature	0 ... 60 °C (32 ... 140 °F)
Storage temperature	-40 ... 85 °C (-40 ... 185 °F)
Relative humidity	90 % , noncondensing

Mechanical specifications

Connection type	5-pin, M12 x 1 connector
Degree of protection	IP54
Material	
Housing	ABS , Polycarbonate , Polyamide (PA)
Mass	500 g

General information

Ordering information	Mounting plate included with delivery
----------------------	---------------------------------------