



Model number

WCS3B-LS267

Read head, RS-485 interface, with RS-485 termination resistor

Features

- RS-485 interface
- Non-contact, absolute position encoder
- Automatic detection of dirt accumulation

Accessories

WCS3B-PL2

Transparent protective case and seal for WCS3B reader

WCS-MP1

Mounting plate for reading heads WCS2 and WCS3

Note

with RS-485 interface

Dimensions

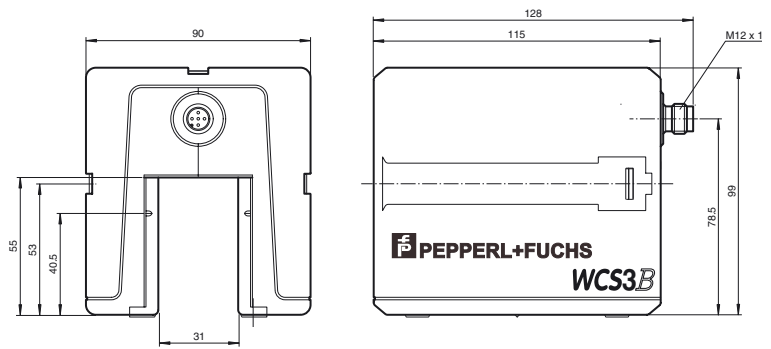

Mounting plate

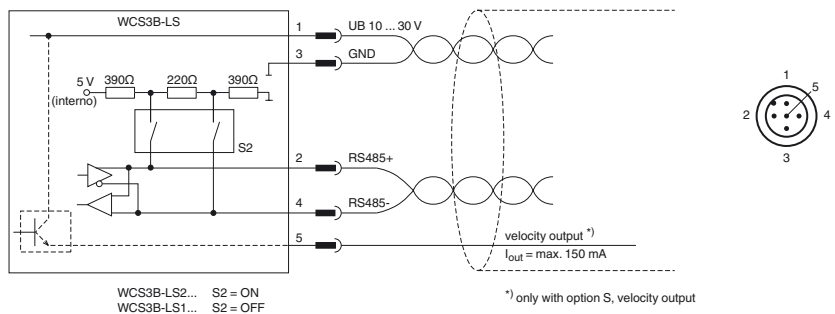
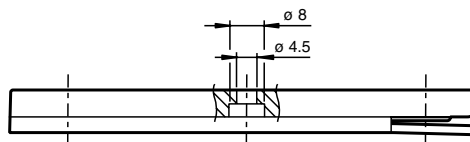
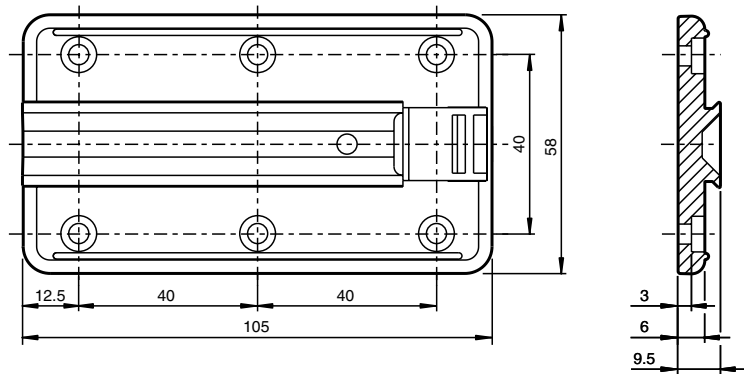

Technical data

General specifications

Passage speed	v	≤ 12.5 m/s
Measuring range		max. 314.5 m
Free tolerances to code rail		horizontal: 31 mm (± 15.5 mm) vertical: 28 mm (± 14 mm)
Resolution		± 0.4 mm (1,250 positions/m)

Release date: 2019-08-21 14:13 Date of issue: 2019-08-21 199290-0024_eng.xml

Functional safety related parameters		
MTTF _d		198 a
Mission Time (T _M)		20 a
Diagnostic Coverage (DC)		0 %
Indicators/operating means		
Operation indicator		LED green: power on
Data flow indicator		LED yellow: data communication active
Error indicator		LED red flashing: read head outside of code rail solid on: internal diagnostic test failed
Electrical specifications		
Operating voltage	U _B	10 ... 30 V DC
Power consumption	P ₀	2 VA
Interface		
Interface type		RS 485 interface
Data output code		binary code
Protocol		3 , without parity (8 bits/byte)
Transfer rate		38.4 kBit/s
Address		0
Termination		with RS 485 termination
Standard conformity		
Emitted interference		DIN EN 61000-6-4 , DIN EN 12015
Noise immunity		DIN EN 61000-6-2 , DIN EN 12016
Shock resistance		DIN EN 60068-2-27, half sine 30 g, 18 ms
Vibration resistance		DIN EN 60068-2-6, sine, 5 g, 10 - 2000 Hz, 10 cycles
Ambient conditions		
Operating temperature		0 ... 60 °C (32 ... 140 °F)
Storage temperature		-40 ... 85 °C (-40 ... 185 °F)
Relative humidity		90 % , noncondensing
Mechanical specifications		
Connection type		5-pin, M12 x 1 connector
Degree of protection		IP54
Material		
Housing		ABS , PC (Polycarbonate)
Mass		500 g
General information		
Ordering information		Mounting plate included with delivery