



Q4XTILAF300-Q8

► Q4X SERIES RUGGED LASER DISTANCE SENSOR



Q4X Series: Laser Adjustable Field

Range: 300 mm; Input 12-30 V dc

Output: Analog: 4-20 mA

Connection: Euro M12 5-Pin Integral Connector

Part Number: 94797

CERTIFICATIONS



SPECIFICATIONS

Sensing Mode (General)	Proximity
Sensing Mode (Detailed)	Background/Foreground Suppression
Housing Style	Rectangular w/M18 Mount
Primary Housing Material	Stainless Steel
Laser Classification	Class 1
Input/Output	Analog
Indicator	Display; LED(s)
Analog Output Configuration	4-20 mA

Analog Resolution/Discrete Repeatability	25 mm to 100 mm: < 0.3 mm; 100 mm to 300 mm: < 1 mm
Max Sensing Distance (mm)	300
Minimum Sensing Distance (mm)	25
Sensing Beam	Visible Red Laser
Power Supply	12-30 V dc
Delay at Power-up (ms)	750
Sensing Beam Wavelength (nm)	655
Adjustments	Push Button; Remote Teach
Temperature Effect (mm/°C)	+/- 0.05 mm/°C from 25 to 125 mm, +/- 0.35 mm/°C at 300 mm
Connection	Integral QD
QD Type/Cable Length	M12 (Euro) requires mating cordset
Number of Pins	5
Vibration	MIL-STD-202G req. Method 201A (vibration:10 to 60Hz max., double amplitude 0.06", max acc. 10G).
Mechanical Shock	MIL-STD-202G, Meth. 213B, Cond. I (100G 6x along X, Y & Z axes, 18 total shocks) w/ sensor operating
Analog Current Output Rating	1 kΩ max @24 V dc, max load resistance = $[(V_{cc}-4.5 V)/0.02 A] \Omega$
Output Protection	Protected against continuous overload and short circuit
IP Rating	IP67; IP68; IP69K
Storage Temperature (°C)	-25 to 75
Max Operating Temperature (°C)	50
Min Operating Temperature (°C)	-10
Max Op. Relative Humidity Non-Condensing (%)	95 at 55°C
Window Material	Acrylic
Warm-up Time (minutes)	10
Minimum Response Time (ms)	0.5
Spot Size (@ Reference Distance)	2.0 mm x 0.8 mm @ 300 mm

Analog Linearity (mm)	+/- 0.75 mm from 25 to 50 mm, 9.0 mm at 300 mm
Barrel Diameter (mm)	18
Minimum Window Size (mm)	2
Laser Control	Yes
Alarm Output (mA)	100
Max Ambient Light (Lux)	5000
Power/Current Consumption (exclusive of load)	< 675 mW
Supply Protection Circuitry	Protected against reverse polarity and transient overvoltages
Feature: Remote Teach	Yes
Feature: Washdown Rated	Yes
Feature: Timing (Hold/Delay)	No
Feature: Ecolab Certified	Yes
Feature: Chemical Resistant	Yes
IO Link	No
Wireless	No

DIAGRAMS

WIRING DIAGRAM

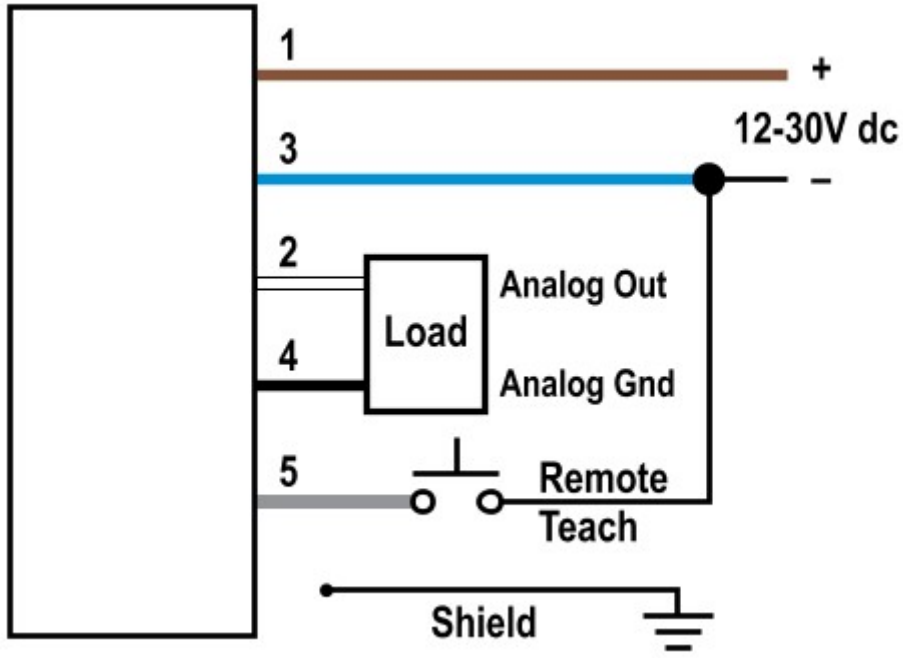

PIN OUT

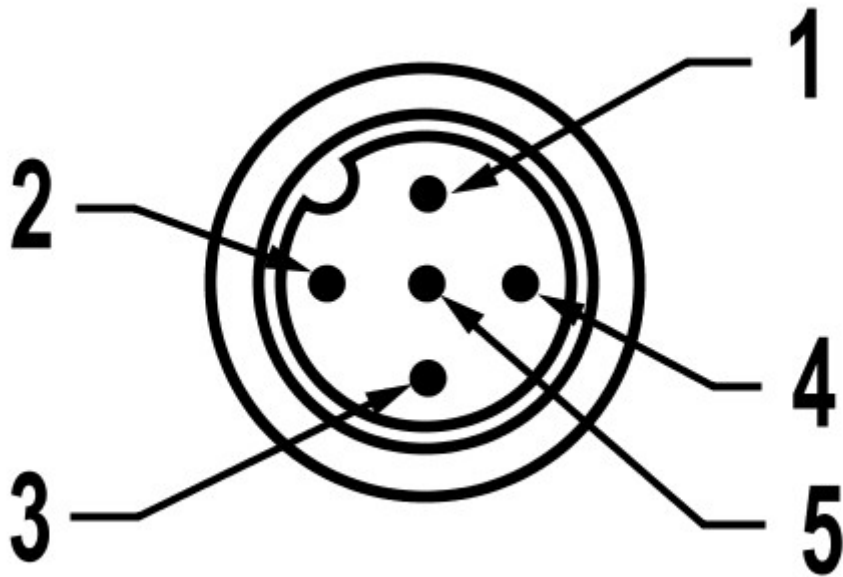

TECH DIAGRAMS

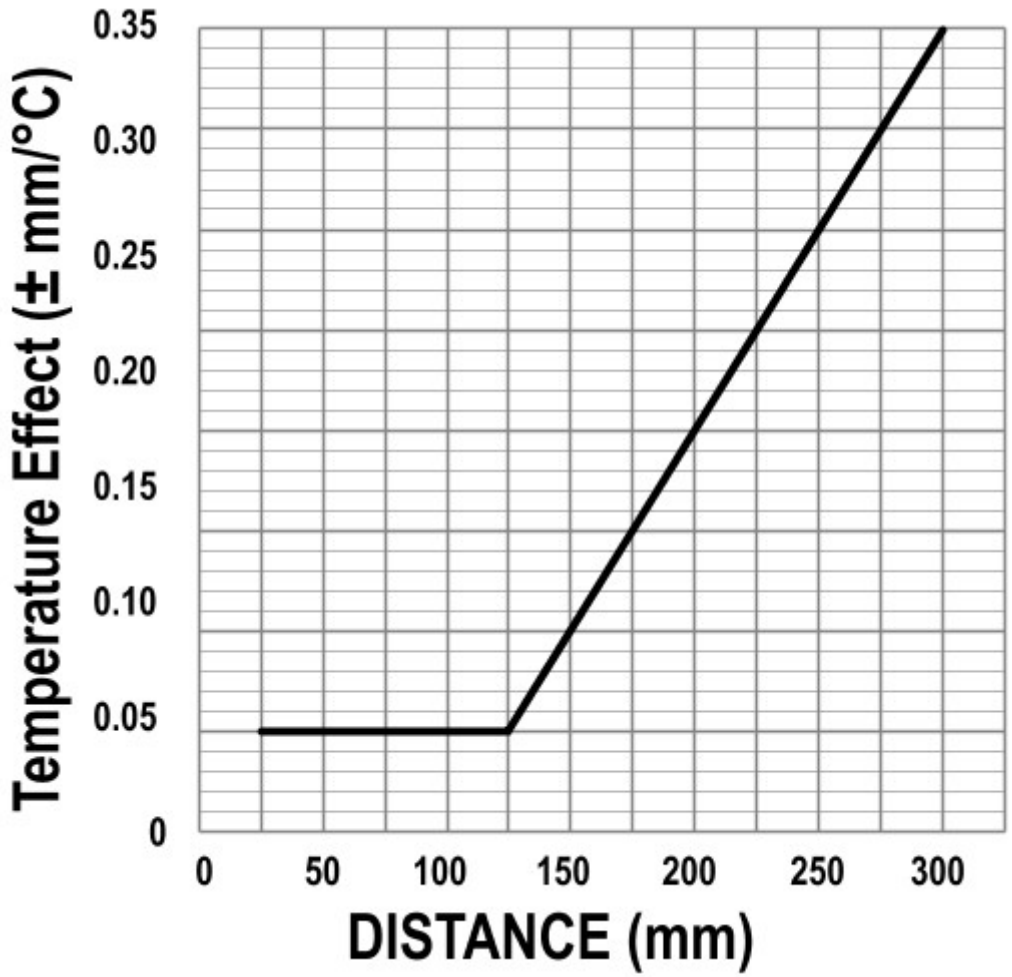



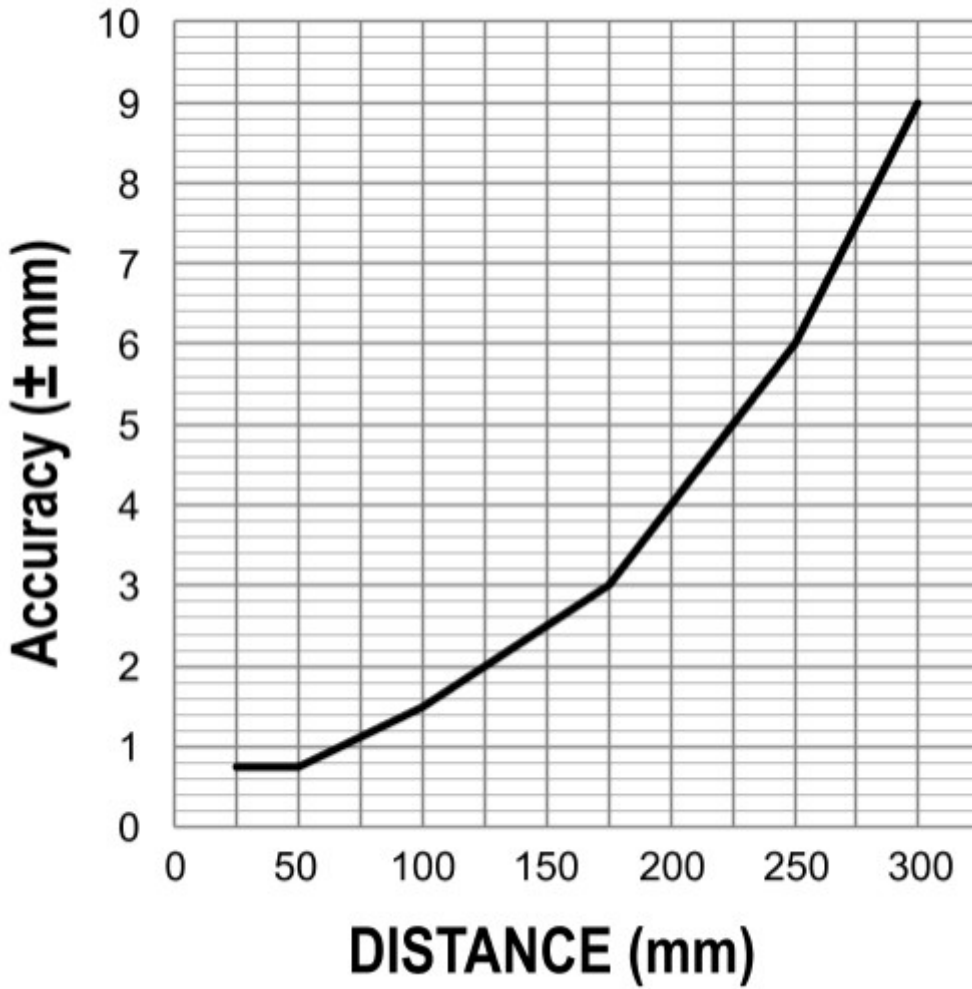



TECH DIAGRAMS







RECOMMENDED PRODUCTS

SINGLE ENDED CORDSETS

	<p>MQDEC2-506RA</p>
	<p>Euro-Style Quick Disconnect Cable with Shield; 5-Pin Right-Angle Connector; 2 m (6.5 ft) in Length; Chrome-plated brass coupling nut</p>
	<p>MQDEC2-515</p>
	<p>Euro-Style Quick Disconnect Cable with Shield; 5-Pin Straight Connector; 5 m (15 ft) in Length; Chrome-plated brass coupling nut</p>
	<p>MQDEC2-515RA</p>
	<p>Euro-Style Quick Disconnect Cable with Shield; 5-Pin Right-Angle Connector; 5 m (15 ft) in Length; Chrome-plated brass coupling nut</p>
	<p>MQDEC2-530</p>
	<p>Euro-Style Quick Disconnect Cable with Shield; 5-Pin Straight Connector.C; 9 m (30 ft) in Length; Chrome-plated brass coupling nut</p>

	MQDEC2-530RA
	Euro-Style Quick Disconnect Cable with Shield; 5-Pin Right-Angle Connector; 9 m (30 ft) in Length; Chrome-plated brass coupling nut
	MQDEC2-506
	Euro-Style Quick Disconnect Cable with Shield; 5-Pin Straight Connector; 2 m (6.5 ft) in Length; Chrome-plated brass coupling nut

ADAPTERS, BRACKETS, CLAMPS AND MOUNTING ACCESSORIES

	SMBQ4XFA
	Bracket: Kit for 12 mm (1/2 in) Rod Bracket Systems; for: Q4X, QS18, QS30; Includes 3/8-16 X 2 in. Socket Head Cap Screw (SHCS)
	SMBQ4XFAM10
	Bracket: Kit for 10 mm (3/8 in) Rod Bracket Systems; for: Q4X, QS18, QS30; Includes M10-1.5 X 50 mm; Socket Head Cap Screw (SHCS)
	SMB18A
	Bracket: 18 mm Right Angle-mount; Material: 11 Gauge Stainless Steel; Curved mounting slot for versatility/orientation ; Clearance for M4 #8 hardware
	SMB18FA
	Bracket: Kit for 12 mm (1/2 in.) Rod Bracket Systems for; most 18 mm barrel mount sensors; lights; and brackets; Includes 3/8-16 X 2 in. Socket Head Cap Screw (SHCS)
	SMB18FAM10
	Bracket: Kit for 10 mm (3/8 in) Rod Bracket Systems for; most 18 mm barrel mount sensors; lights; and brackets; Includes M10-1.5 X 50 mm Socket Head Cap Screw (SHCS)
	SMB18FAM12
	Bracket: Kit for 12 mm (1/2 in) Rod Bracket Systems for; most 18 mm threaded barrel sensors; lights; and brackets; No Socket Head Cap Screw (SHCS) included
	SMBQ4XFAM12
	Bracket: Kit for 12 mm (1/2 in) Rod Bracket Systems; for: Q4X, QS18, QS30; No Socket Head Cap Screw (SHCS) included

ACCESSORIES

	APC-18
	APC-18 AIR PURGE COLLAR



APC-18P

APC-18P AIR PURGE COLLAR DELRIN



Banner Engineering Corp. | 9714 Tenth Avenue North | Minneapolis, MN 55441 | United States of America