



Q4XTBLAF300-Q8

► Q4X SERIES RUGGED LASER DISTANCE SENSOR



Q4X Series: Laser Adjustable Field

Range: 300 mm; Input 10-30 V dc

Outputs: Bipolar: 1 NPN; 1 PNP

Connection: Euro M12 5-Pin Integral Connector

Part Number: 94118

CERTIFICATIONS



SPECIFICATIONS

Sensing Mode (General)	Proximity
Sensing Mode (Detailed)	Background/Foreground Suppression
Housing Style	Rectangular w/M18 Mount
Primary Housing Material	Stainless Steel
Laser Classification	Class 1
Input/Output	Discrete
Indicator	Display; LED(s)
Analog Resolution/Discrete Repeatability	25 mm to 50 mm: +/-0.5 mm; 50 mm to 300 mm: +/- 1% of range

Max Sensing Distance (mm)	300
Minimum Sensing Distance (mm)	25
Sensing Beam	Visible Red Laser
Power Supply	10-30 V dc
Delay at Power-up (ms)	750
Sensing Beam Wavelength (nm)	655
Adjustments	Push Button; Remote Teach
Temperature Effect (mm/°C)	+/- 0.05 mm/°C from 25 to 125 mm, +/- 0.35 mm/°C at 300 mm
Connection	Integral QD
QD Type/Cable Length	M12 (Euro) requires mating cordset
Number of Pins	5
Vibration	MIL-STD-202G req. Method 201A (vibration:10 to 60Hz max., double amplitude 0.06", max acc. 10G).
Mechanical Shock	MIL-STD-202G, Meth. 213B, Cond. I (100G 6x along X, Y & Z axes, 18 total shocks) w/ sensor operating
Output Saturation Voltage NPN Outputs	<1.0 V @ 100 mA
Output Saturation Voltage PNP Outputs	<1.5 V @ 100 mA
Max Discrete (Switched) Output (mA)	100
Discrete (Switched) Outputs	Bipolar (NPN & PNP)
Output Protection	Protected against continuous overload and short circuit
IP Rating	IP67; IP68; IP69K
Storage Temperature (°C)	-25 to 75
Max Operating Temperature (°C)	50
Min Operating Temperature (°C)	-10
Max Op. Relative Humidity Non-Condensing (%)	95 at 55°C
Window Material	Acrylic
Warm-up Time (minutes)	10

Minimum Response Time (ms)	1.5
Spot Size (@ Reference Distance)	2.0 mm x 0.8 mm @ 300 mm
Barrel Diameter (mm)	18
Minimum Window Size (mm)	0.4
Discrete Output Hysteresis (mm)	Automatically adjusted
Laser Control	Yes
Alarm Output (mA)	100
Max Ambient Light (Lux)	5000
Max Off-state Leakage Current (μA)	5 @ 30 V dc
Power/Current Consumption (exclusive of load)	< 675 mW
Supply Protection Circuitry	Protected against reverse polarity and transient overvoltages
Feature: Remote Teach	Yes
Feature: Washdown Rated	Yes
Feature: Clear Object Detection	Yes
Feature: Timing (Hold/Delay)	Yes
Feature: Ecolab Certified	Yes
Feature: Chemical Resistant	Yes
IO Link	No
Wireless	No

DIAGRAMS

WIRING DIAGRAM

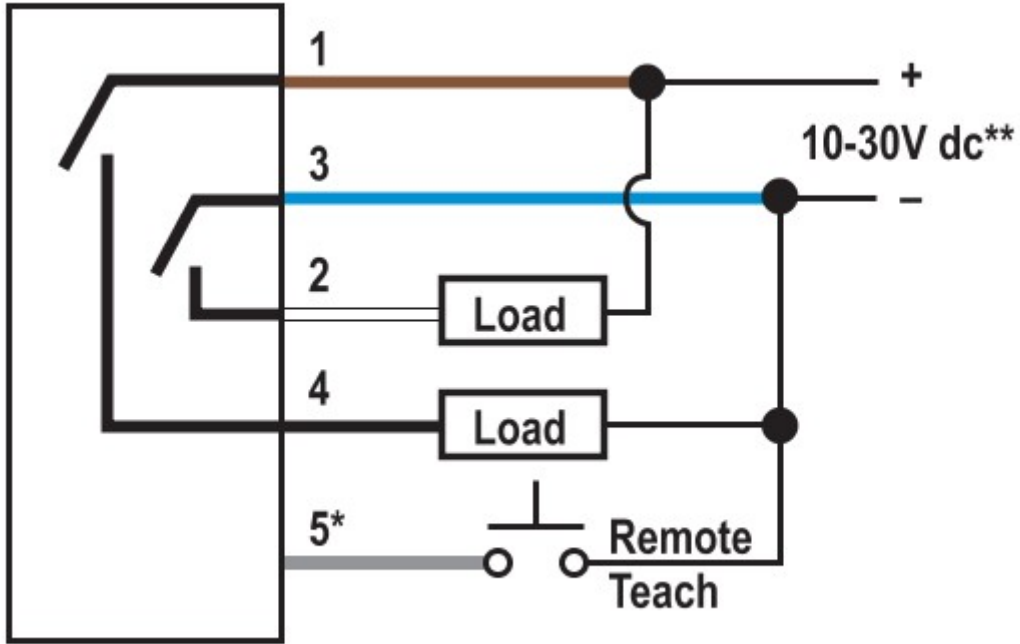

PIN OUT

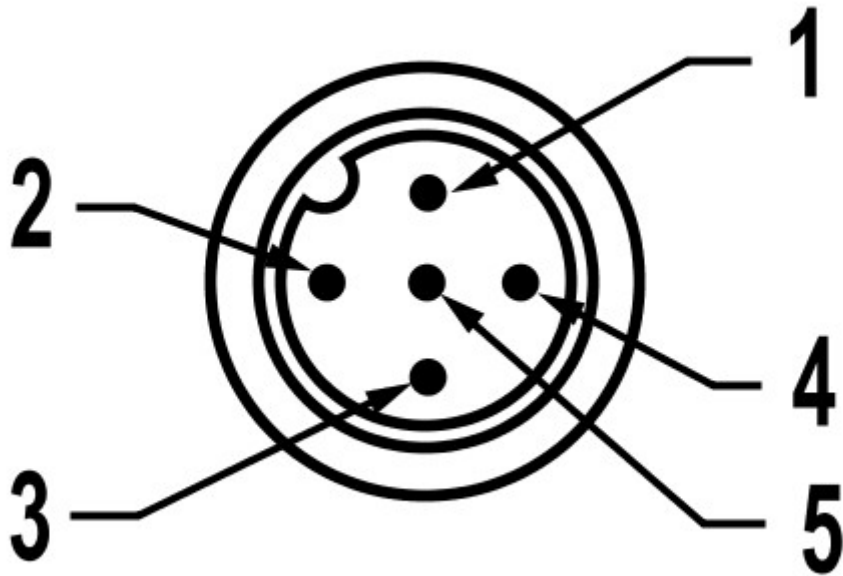



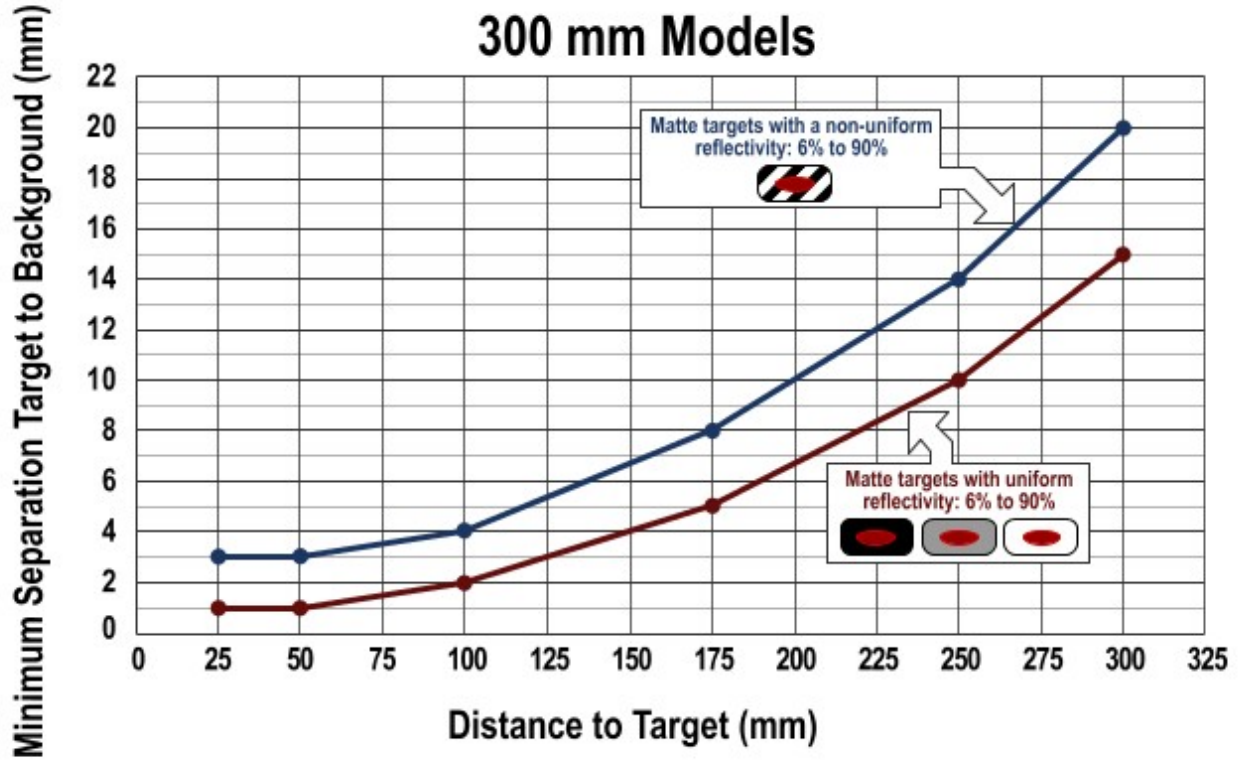

TECH DIAGRAMS



RECOMMENDED PRODUCTS

SINGLE ENDED CORDSETS

	<p>MQDC-WDSS-0506</p>	<p>Euro-style Quick Disconnect Cable; 5-Pin Straight Connector for F&B Applications; 2 m (6.5 ft) in Length abrasion resistant PVC cable; Stainless Steel hex coupling nut and EPDM o-ring</p>
	<p>MQDC-WDSS-0515</p>	<p>Euro-style Quick Disconnect Cable; 5-Pin Straight Connector for F&B Applications; 5 m (15 ft) in Length abrasion resistant PVC cable; Stainless Steel hex coupling nut and EPDM o-ring</p>
	<p>MQDC1-506</p>	<p>Euro-style Quick Disconnect Cable; 5 Pin Straight Connector; 2 m (6.5 ft) in Length; Chrome plated brass coupling nut</p>
	<p>MQDC-WDSS-0530</p>	<p>Euro-style Quick Disconnect Cable; 5-Pin Straight Connector for F&B Applications; 9 m (30 ft) in Length abrasion resistant PVC cable; Stainless Steel hex coupling nut and EPDM o-ring</p>
	<p>MQDC1-515</p>	<p>Euro-style Quick Disconnect Cable; 5 Pin Straight Connector; 5 m (15 ft) in Length; Chrome plated brass coupling nut</p>

	<p>MQDC1-530</p> <p>Euro-style Quick Disconnect Cable; 5 Pin Straight Connector; 9 m (30 ft) in Length; Chrome plated brass coupling nut</p>
	<p>MQDC1-506RA</p> <p>Euro-Style Quick Disconnect Cable; 5-Pin Right-Angle Connector; 2 m (6.5 ft) in Length; Chrome-plated brass coupling nut</p>
	<p>MQDC1-515RA</p> <p>Euro-Style Quick Disconnect Cable; 5-Pin Right-Angle Connector; 5 m (15 ft) in Length; Chrome-plated brass coupling nut</p>
	<p>MQDC1-530RA</p> <p>Euro-Style Quick Disconnect Cable; 5-Pin Right-Angle Connector; 9 m (30 ft) in Length; Chrome-plated brass coupling nut</p>



ADAPTERS, BRACKETS, CLAMPS AND MOUNTING ACCESSORIES

	<p>SMBQ4XFA</p> <p>Bracket: Kit for 12 mm (1/2 in) Rod Bracket Systems; for: Q4X, QS18, QS30; Includes 3/8-16 X 2 in. Socket Head Cap Screw (SHCS)</p>
	<p>SMBQ4XFAM10</p> <p>Bracket: Kit for 10 mm (3/8 in) Rod Bracket Systems; for: Q4X, QS18, QS30; Includes M10-1.5 X 50 mm; Socket Head Cap Screw (SHCS)</p>
	<p>SMBQ4XFAM12</p> <p>Bracket: Kit for 12 mm (1/2 in) Rod Bracket Systems; for: Q4X, QS18, QS30; No Socket Head Cap Screw (SHCS) included</p>
	<p>SMB18FA</p> <p>Bracket: Kit for 12 mm (1/2 in.) Rod Bracket Systems for; most 18 mm barrel mount sensors; lights; and brackets; Includes 3/8-16 X 2 in. Socket Head Cap Screw (SHCS)</p>
	<p>SMB18FAM10</p> <p>Bracket: Kit for 10 mm (3/8 in) Rod Bracket Systems for; most 18 mm barrel mount sensors; lights; and brackets; Includes M10-1.5 X 50 mm Socket Head Cap Screw (SHCS)</p>
	<p>SMB18FAM12</p> <p>Bracket: Kit for 12 mm (1/2 in) Rod Bracket Systems for; most 18 mm threaded barrel sensors; lights; and brackets; No Socket Head Cap Screw (SHCS) included</p>
	<p>SMB18A</p> <p>Bracket: 18 mm Right Angle-mount; Material: 11 Gauge Stainless Steel; Curved mounting slot for versatility/orientation ; Clearance for M4 #8 hardware</p>

REFERENCE TARGET

	BRT-Q4X-60X18
Reflector; Q4X Clear Object Detection; Rectangular 60 mm X 18 mm	
	BRT-Q4X-60X50
Reflector; Q4X Clear Object Detection; Rectangular 60 mm X 50 mm	

ACCESSORIES

	APC-18
APC-18 AIR PURGE COLLAR	
	APC-18P
APC-18P AIR PURGE COLLAR DELRIN	



Banner Engineering Corp. | 9714 Tenth Avenue North | Minneapolis, MN 55441 | United States of America