

CE The CE Mark verifies that our products meet the requirements of the current EU Directive.

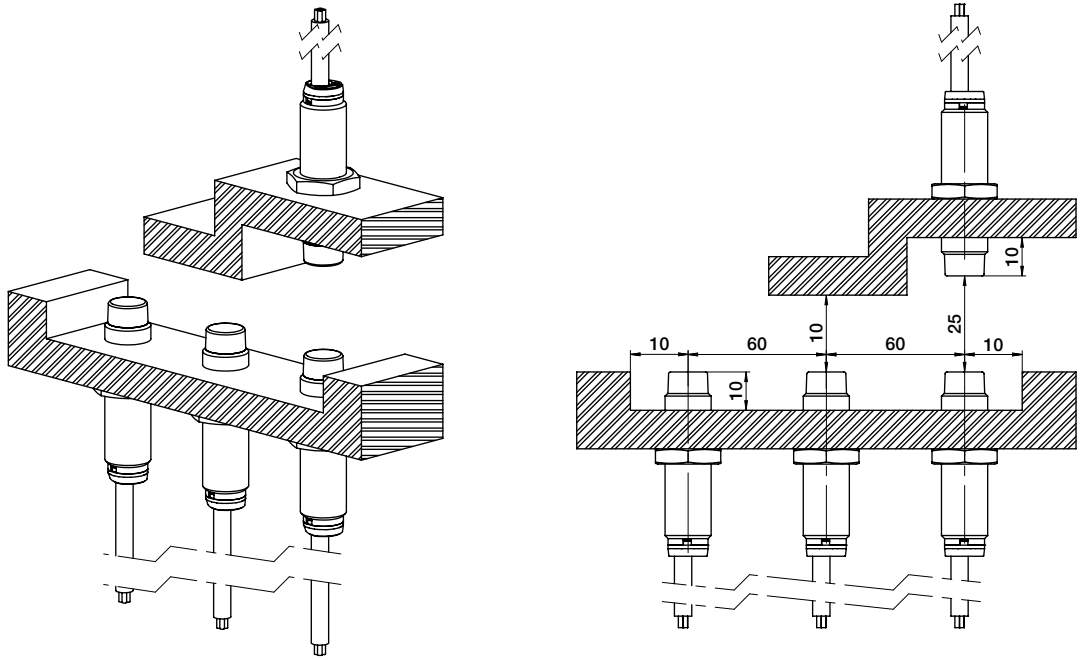

Balluff GmbH
 Schurwaldstrasse 9
 73765 Neuhausen a.d.F.
 Germany
 Phone + 49 7158 173-0
www.balluff.com/go/support

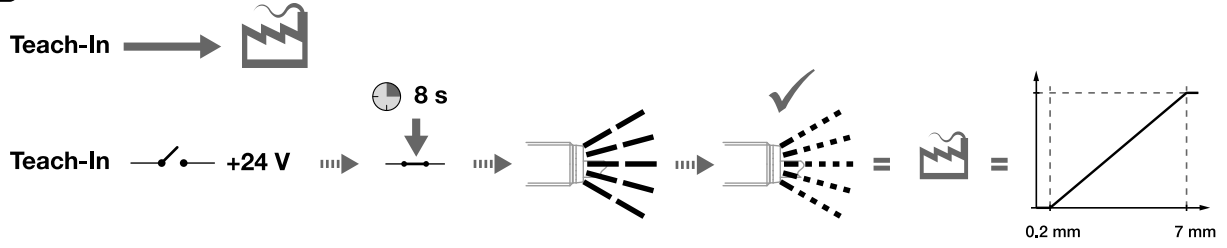

BAW M12 _ _ _ **-I** _ _ _ **G-BP** _ **-GS04**
BAW M12 _ _ _ **-U** _ _ _ **G-BP** _ **-GS04**

Teach-In

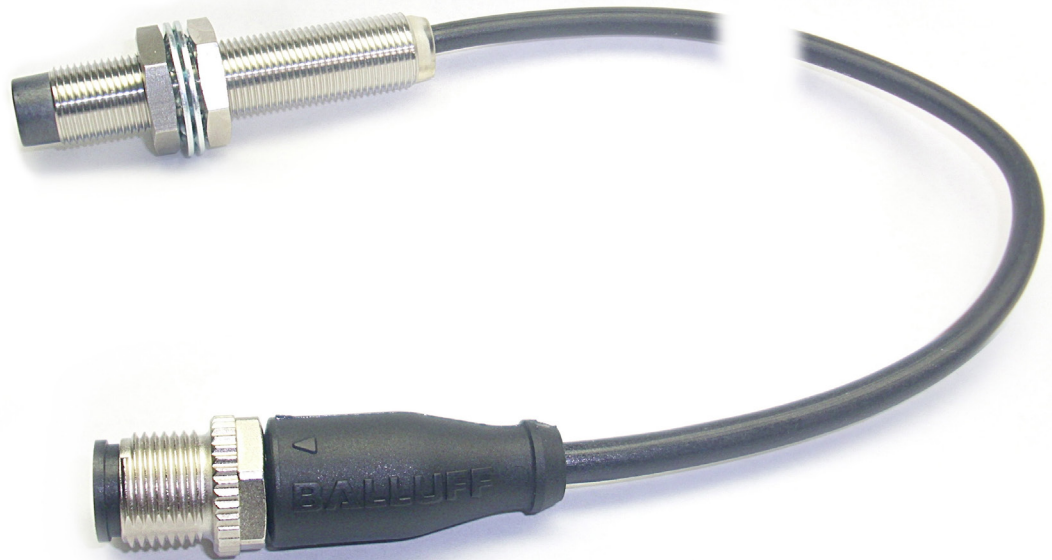



Only for use in NFPA 79 Applications.

Utilisation exclusive dans les applications.

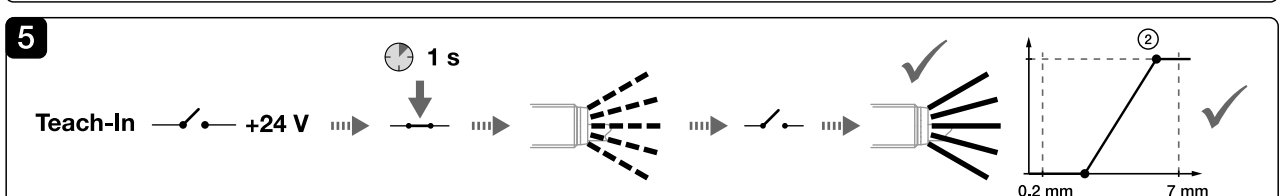
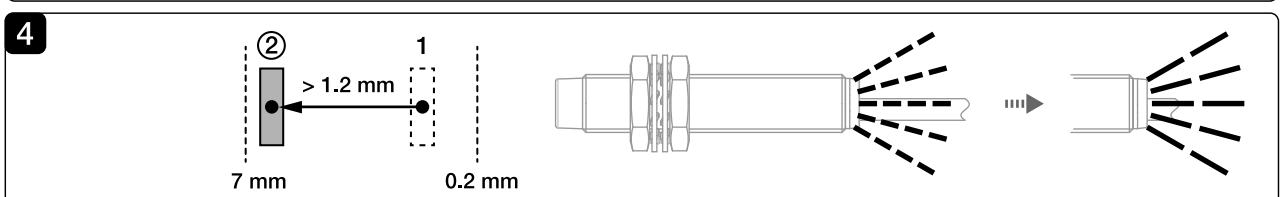
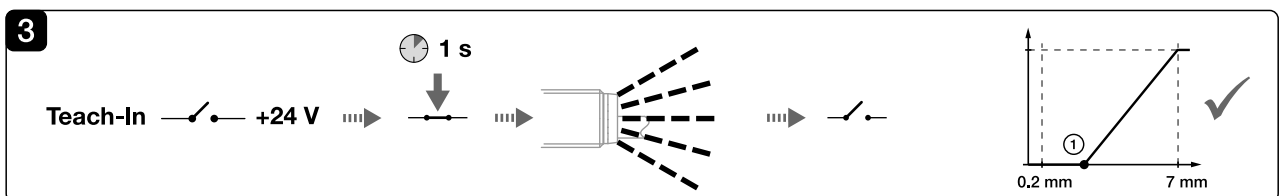
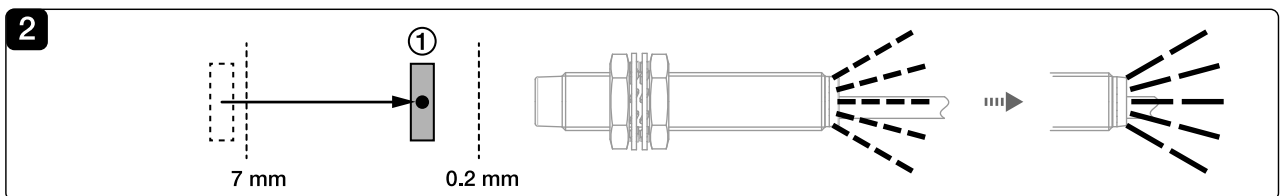
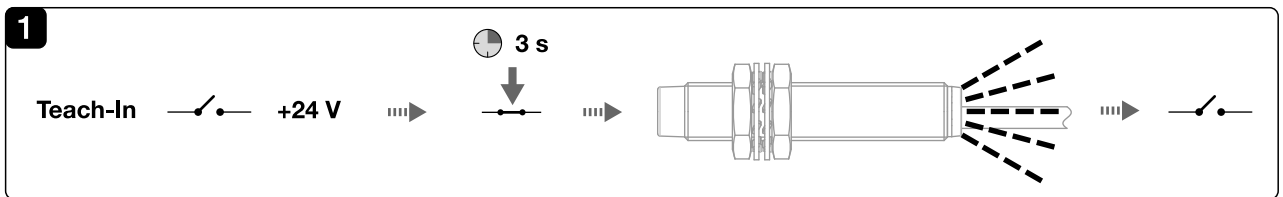
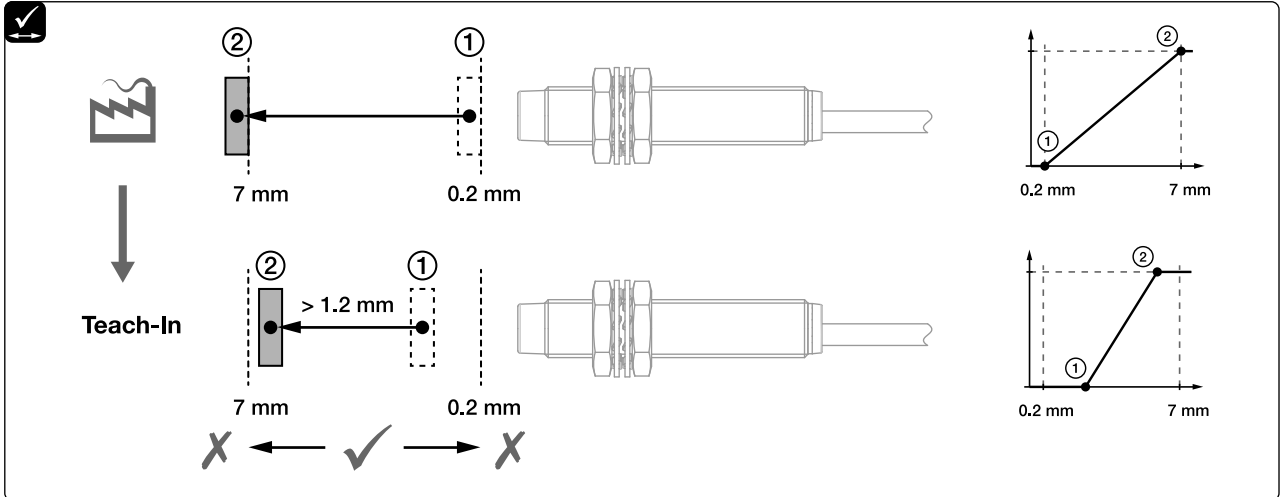
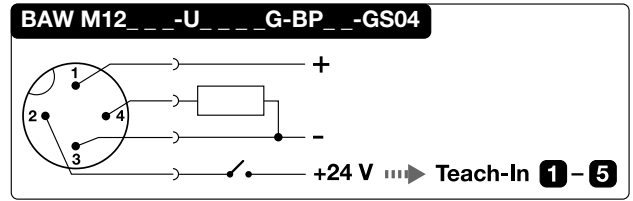
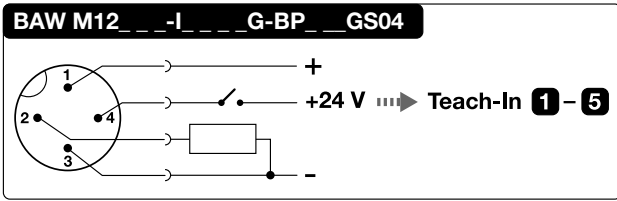



Adapters providing field wiring means are available from the manufacturer. Refer to manufacturers information.

Des adaptateurs permettant un câblage sur le terrain sont disponibles auprès du fabricant. Se référer aux informations du fabricant.

