

Operating instructions Through-beam sensor with IO-Link

UK

OGE
OGS

80282420 / 00 08 / 2022

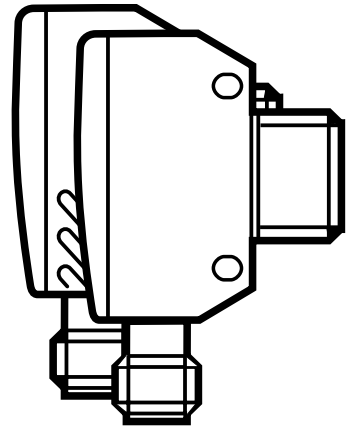

Contents

1 Preliminary note.....	3
1.1 Symbols used	3
2 Safety instructions	3
3 Functions and features	3
4 Installation.....	4
5 Electrical connection.....	4
5.1 Transmitter.....	4
5.2 Receiver.....	5
5.2.1 PNP	5
5.2.2 NPN	5
6 Settings.....	5
6.1 Set via IO-Link	5
6.1.1 Set sensitivity with object.....	6
6.1.2 Set maximum sensitivity	6
7 Operation	7
8 Maintenance, repair, disposal.....	7

1 Preliminary note

Technical data, approvals, accessories and further information at www.ifm.com.

1.1 Symbols used

► Instruction

> Reaction, result

[...] Designation of keys, buttons or indications

→ Cross-reference



Information

Supplementary note.



Important note

Non-compliance may result in malfunction or interference.

UK

2 Safety instructions

- Read this document before setting up the product and keep it during the entire service life.
- The product must be suitable for the corresponding applications and environmental conditions without any restrictions.
- Only use the product for its intended purpose (→ 3 Functions and features).
- If the operating instructions or the technical data are not adhered to, personal injury and/or damage to property may occur.
- The manufacturer assumes no liability or warranty for any consequences caused by tampering with the product or incorrect use by the operator.
- Installation, electrical connection, set-up, operation and maintenance of the product must be carried out by qualified personnel authorised by the machine operator.
- Protect units and cables against damage.

3 Functions and features

The through-beam sensor detects objects and materials without contact and indicates their presence by a switching signal.

For the range see the type label.

4 Installation

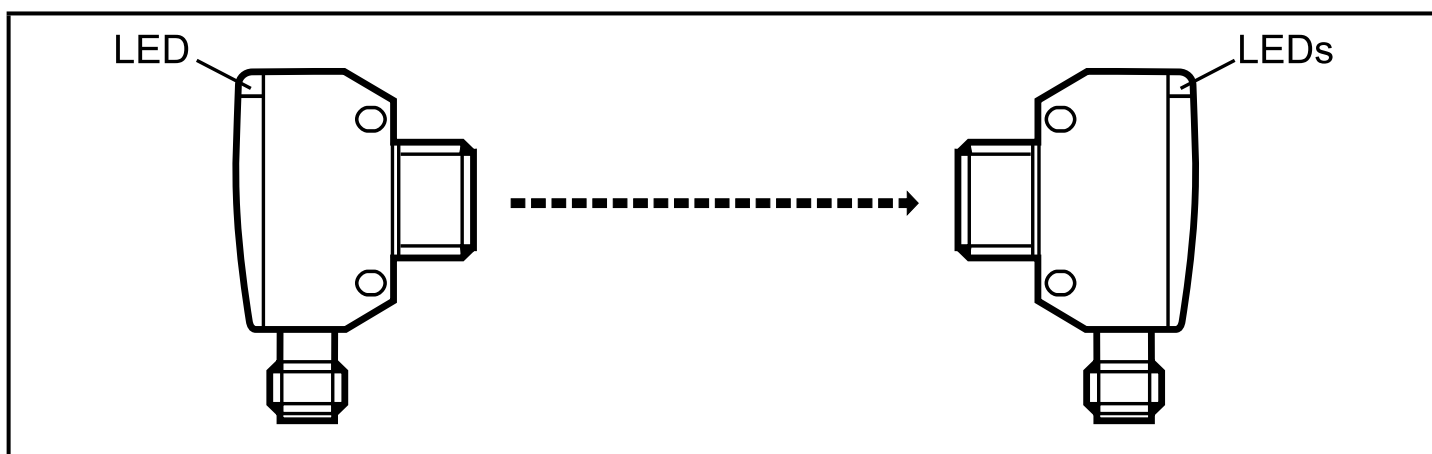

- ▶ Secure the receiver to a bracket.
- ▶ Align the transmitter to the receiver and also secure it to a bracket.
- > Maximum range only with accurate alignment.

5 Electrical connection



The unit must be connected by a qualified electrician.

- ▶ The national and international regulations for the installation of electrical equipment must be adhered to.
- ▶ Ensure voltage supply to EN 50178.
- ▶ Disconnect power.
- ▶ Connect the unit as follows:

5.1 Transmitter

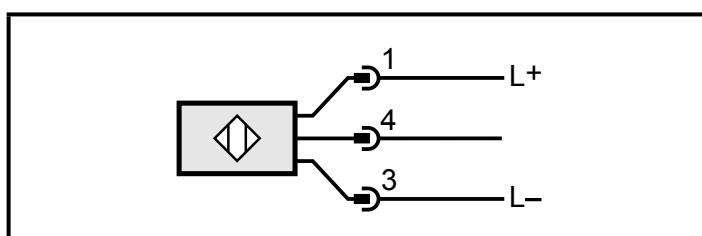

Pin 1 = L+ (10...30 V DC)

Pin 3 = L-

Pin 4 = IO-Link

(Pin 2 = not connected)

5.2 Receiver

5.2.1 PNP

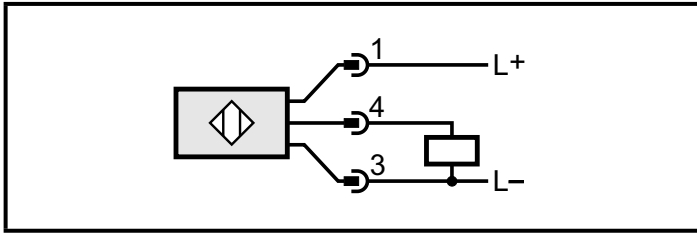

Pin 1 = L+ (10...30 V DC)

Pin 3 = L-

Pin 4 = load (PNP, 200 mA) / IO-Link
(Pin 2 = not connected)

5.2.2 NPN

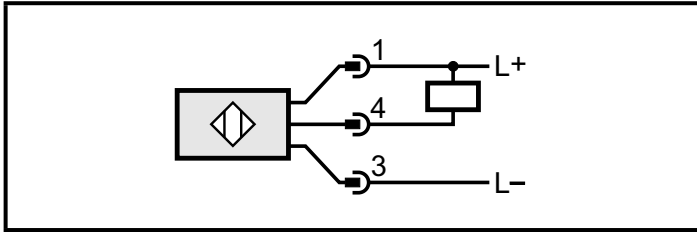

Pin 1 = L+ (10...30 V DC)

Pin 3 = L-

Pin 4 = load (NPN, 200 mA) / IO-Link
(Pin 2 = not connected)

UK

6 Settings

6.1 Set via IO-Link

This unit has an IO-Link communication interface which enables direct access to process and diagnostic data. In addition it is possible to set the parameters of the unit while it is in operation. Operation of the unit via the IO-Link interface requires an IO-Link master.

With a PC, suitable IO-Link software and an IO-Link adapter cable communication is possible while the system is not in operation.

The IODDs necessary for the configuration of the unit, detailed information about process data structure, diagnostic information, parameter addresses and the necessary information about the required IO-Link hardware and software can be found at www.ifm.com.

6.1.1 Set sensitivity with object

- ▶ Start the parameter setting software (e.g. moneo configure SA).
- ▶ Select [Parameter] > [Teach].
- ▶ Align the transmitter to the object (fig. 1).
- ▶ Click on the [Teach SP1 TP1] button in the parameter setting software.
- ▶ Align the transmitter to the receiver (fig. 2).
- ▶ Click on the [Teach SP1 TP2] button in the parameter setting software.

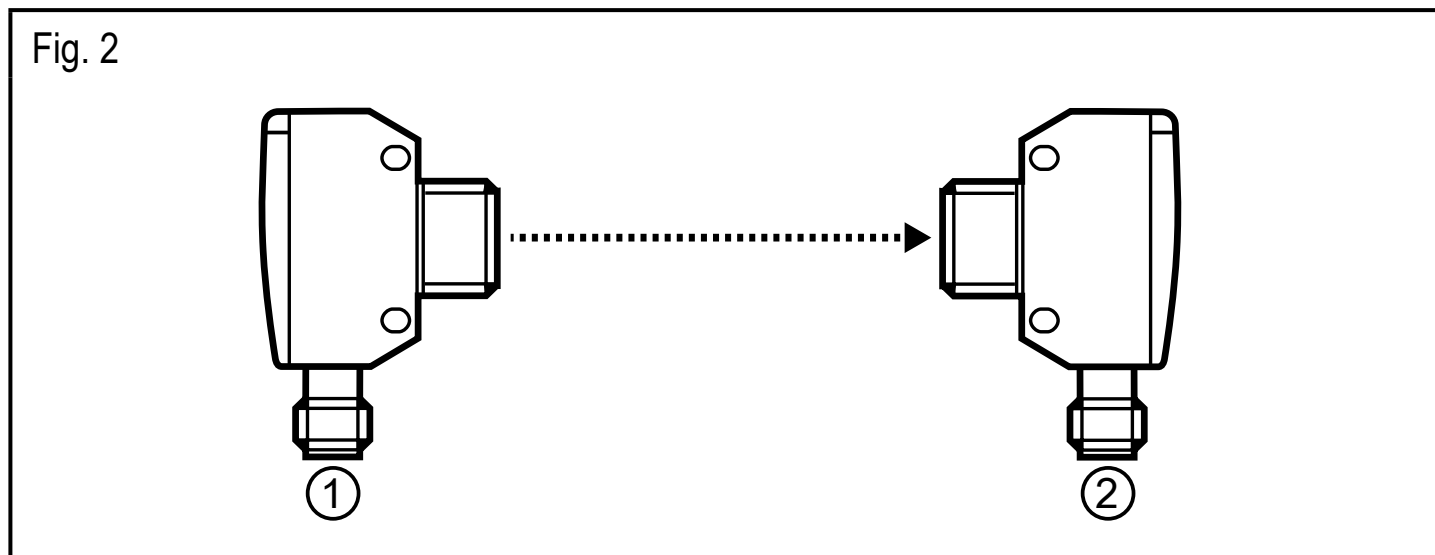
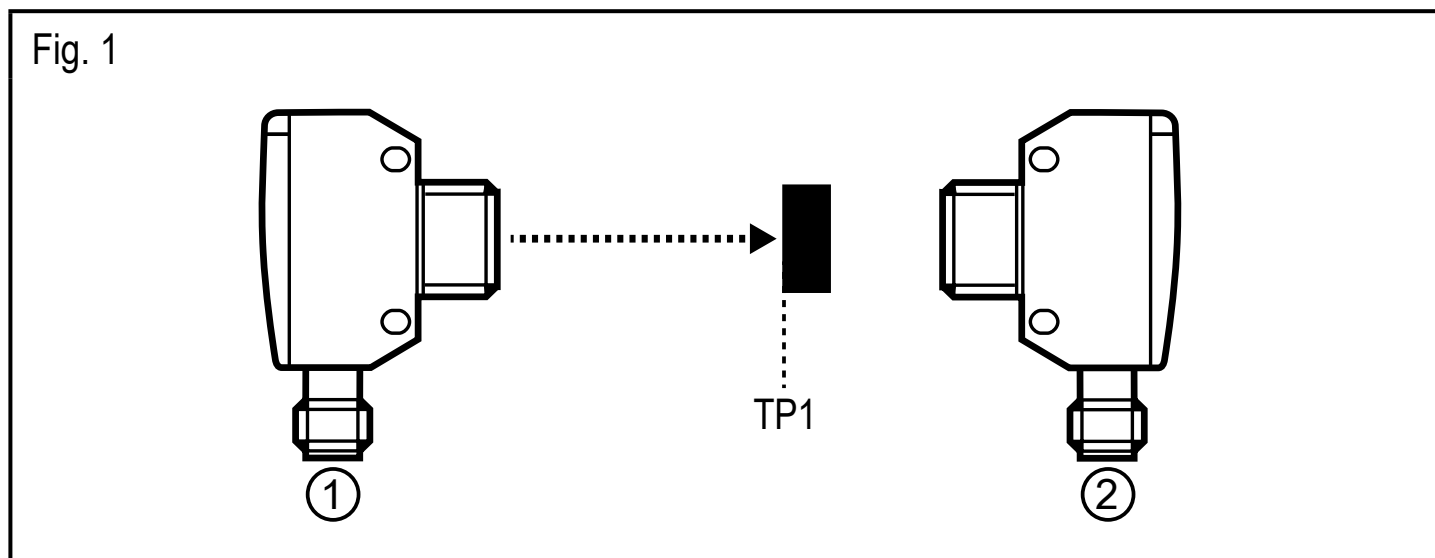

1: transmitter; 2: receiver; TP1: teach point 1; TP2: teach point 2

 Either the object can be set first and then the background, or the other way around.

6.1.2 Set maximum sensitivity

- ▶ Start the parameter setting software (e.g. moneo configure SA).
- ▶ Select [Parameter] > [Teach].
- ▶ Align the object so that no light is received.

- ▶ Click on the [Teach SP1 TP1] button in the parameter setting software.
- ▶ Click on the [Teach SP1 TP2] button in the parameter setting software.

7 Operation

- ▶ Check whether the unit operates correctly.
 - > The green LED is on when the unit is ready for operation.
 - > Receiver: The yellow LED is on when the switching output is switched. The green LED is on when the unit is ready for operation.
 - > Transmitter: The green LED is on when the unit is ready for operation.

UK

8 Maintenance, repair, disposal

- ▶ Keep the lens of the sensor free from soiling.
- ▶ For cleaning do not use any solvents or cleaning agents which could damage the plastic parts.
- ▶ After use dispose of the unit in an environmentally friendly way in accordance with the applicable national regulations.

Faulty sensors must only be repaired by the manufacturer.