

Operating instructions
Compressed air meters

SDG070

SDG080

SDG100

SDG150

SDG200

UK

706375 / 00 01 / 2021

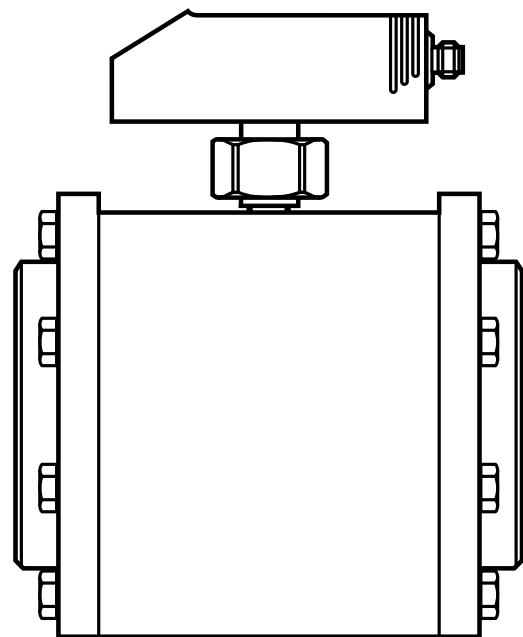

Contents

1	Preliminary note.....	3
1.1	Symbols used	3
2	Safety instructions	3
3	Items supplied.....	4
4	Functions and features	4
5	Function.....	5
5.1	Processing of the measured signals.....	5
5.2	Volumetric flow monitoring.....	5
5.3	Consumed quantity monitoring (totalizer function)	6
5.4	Switching function.....	6
5.5	Analogue function	7
6	Installation.....	8
6.1	Installation location	8
6.2	Installation conditions	8
6.3	Installation position	9
6.4	Install the pipe section into the pipe	9
6.5	Insert the sensor into the pipe section.....	10
7	Electrical connection.....	11
8	Operating and display elements	12
9	Menu.....	13
10	Parameter setting	15
10.1	General parameter setting.....	15
10.2	Settings for volumetric flow monitoring.....	16
10.2.1	Limit monitoring volumetric flow (OUT1)	16
10.2.2	Limit monitoring volumetric flow (OUT2)	16
10.2.3	Analogue output flow rate (OUT2).....	17
10.3	Settings for consumed quantity monitoring	17
10.3.1	Quantity monitoring by pulse output (OUT1).....	17
10.3.2	Quantity monitoring by preset counter (OUT1).....	17
10.3.3	Manual counter reset.....	17
10.3.4	Time-controlled counter reset.....	17
10.3.5	Deactivation of the counter reset.....	17

10.3.6 Counter reset using an external signal	18
10.4 Settings for temperature monitoring	18
10.4.1 Limit monitoring temperature (OUT2).....	18
10.4.2 Analogue output temperature (OUT2)	18
10.5 User settings (optional).....	18
10.5.1 Standard unit of measurement for volumetric flow	18
10.5.2 Standard display	19
10.5.3 Measured value damping	19
10.5.4 Error behaviour of the outputs	19
10.5.5 Setting of the standard pressure	19
10.5.6 Setting of the standard temperature	19
10.5.7 Low flow cut-off.....	20
10.6 Service functions	20
10.6.1 Read min/max values	20
10.6.2 Restoring the factory settings	20
11 Operation	20
11.1 Reading of the set parameters.....	20
11.2 Changing the display unit in the Run mode	21
11.3 Error indications	21
11.4 General operating conditions	21
12 Technical data and scale drawing.....	21

UK

1 Preliminary note

1.1 Symbols used

- ▶ Instruction
- > Reaction, result
- [...] Designation of pushbuttons, buttons or indications
- Cross-reference



Important note

Non-compliance can result in malfunction or interference.

2 Safety instructions

- Please read this document prior to set-up of the unit. Ensure that the product is suitable for your application without any restrictions.

- If the operating instructions or the technical data are not adhered to, personal injury and/or damage to property can occur.
- Ensure before mounting the components into or removing them from the compressed air system that the installation is at a standstill and no pressure is applied.
- Improper or non-intended use may lead to malfunctions of the unit or to unwanted effects in your application. That is why installation, electrical connection, set-up, operation and maintenance of the unit must only be carried out by qualified personnel authorised by the machine operator.
- In order to guarantee the correct condition of the device for the operating time the device must only be used in media to which the wetted parts are sufficiently resistant (→ Technical data).
- The responsibility whether the measurement devices are suitable for the respective application lies with the operator. The manufacturer assumes no liability for consequences of misuse by the operator. Improper installation and use of the devices result in a loss of the warranty claims.

3 Items supplied

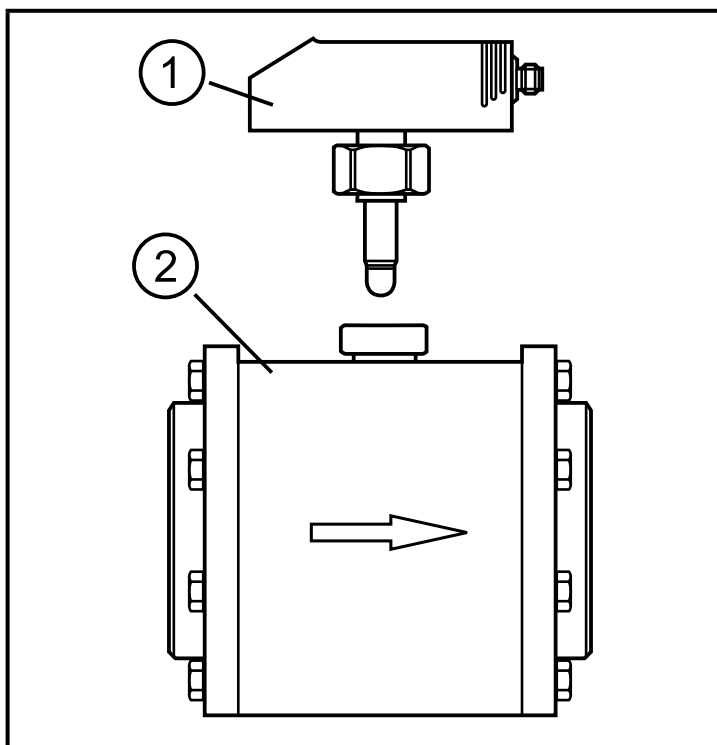

1: flow sensor
2: pipe section

4 Functions and features

The unit monitors the standard volume flow of compressed air in industrial use. It detects the process categories volumetric flow quantity and consumed quantity.

Application area: compressed air systems in industrial use.

All indications apply for standard volume flow to DIN ISO 2533, i.e. volume flow at 1013 hPa, 15 °C and 0 % relative air humidity. The unit can be set to different standard conditions (→ 10.5.5 and → 10.5.6).

The general operating conditions of compressed air equipment apply.

Pressure Equipment Directive (PED):

The units comply with the Pressure Equipment Directive. They are designed for group 2 fluids and manufactured and tested according to Module A.

Use of media from group 1 fluids on request.

UK

5 Function

5.1 Processing of the measured signals

- The unit displays the current process values.
- It generates 2 output signals according to the parameter setting.

OUT1 3 selection options parameter setting

- switching signal for volumetric flow limit values (→ 10.2.1)
- pulse sequence for quantity meter (→ 10.3.1)
- switching signal for preset counter (→ 10.3.2)

OUT2: 5 selection options

- switching signal for volumetric flow limit values (→ 10.2.2)
- switching signal for temperature (→ 10.4.1)
- analogue signal for volumetric flow quantity (→ 10.2.3)
- analogue signal for temperature (→ 10.4.2)
- input for external counter reset signal (→ 10.3.6)

5.2 Volumetric flow monitoring

The flow is monitored by a calorimetric measuring system.

- 2 switching signals for volumetric flow limit values can be provided (output 1 and output 2). Switching functions → 5.4.
- An analogue signal which is proportional to the volumetric flow (4...20 mA) can be provided on output 2. Analogue function → 5.5.

5.3 Consumed quantity monitoring (totalizer function)

The unit has an internal quantity meter which continuously totals the volumetric flow. The sum corresponds to the current consumed quantity since the last reset.

- Output 1 can be configured as pulse output. Output 1 provides a counting pulse each time when the value set in [ImPS] is reached (→ 10.3).
- The current meter reading can be displayed.
- In addition the value before the last reset is stored. This value can also be displayed.

The meter saves the totalled consumed quantity every 10 minutes. After a power failure this value is available as the current meter reading. If a time-controlled reset is set, the elapsed time of the set reset interval is also stored. So the possible data loss can be maximum 10 minutes.

The meter can be reset as follows:

- Manual reset (→ 10.3.3)
- Time-controlled automatic reset (→ 10.3.3)
- Reset after overflow (→ 10.3.5)

5.4 Switching function

OUTx changes its switching status if it is above or below the set switching limits. Hysteresis or window function can be selected.

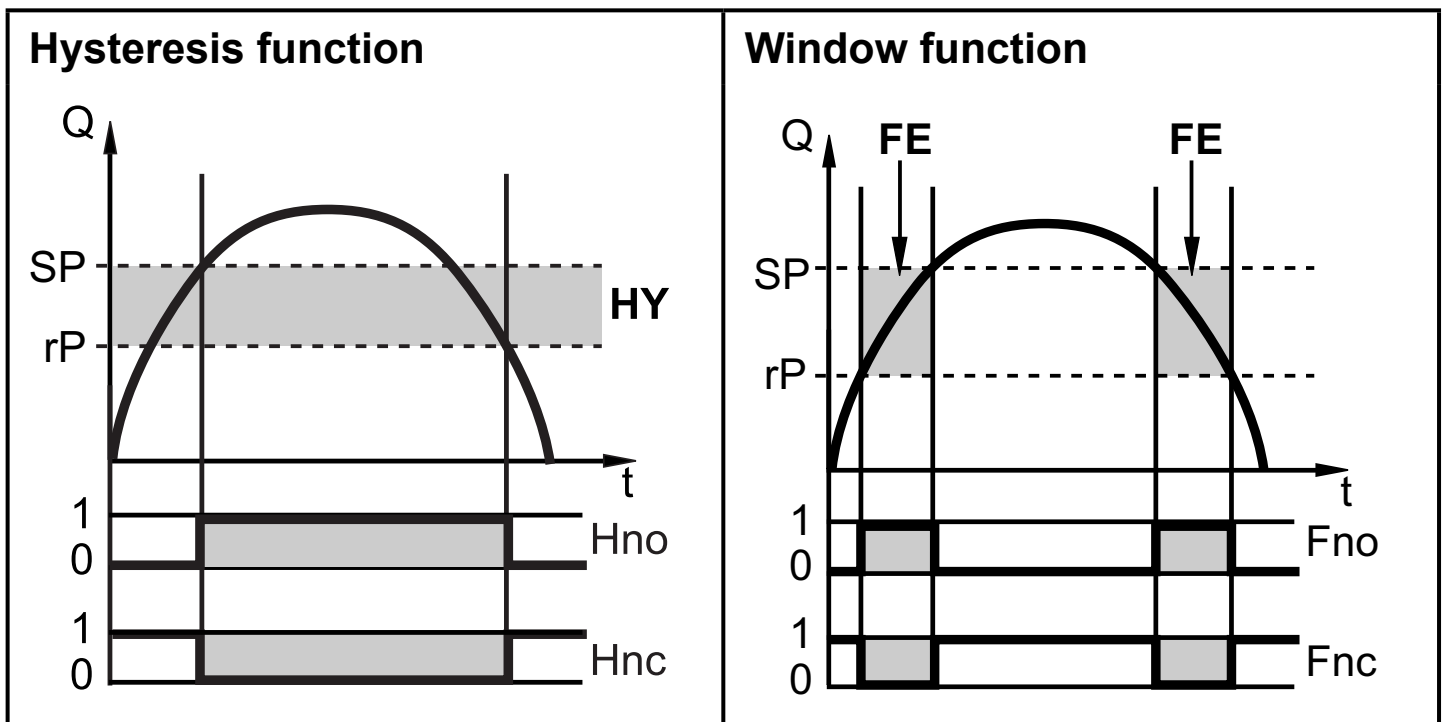

SP = set point
 rP = reset point
 HY = hysteresis
 Hno = hysteresis NO (normally open)
 Hnc = hysteresis NC (normally closed)

SP = upper limit
 rP = lower limit
 FE = window
 Fno = window NO (normally open)
 Fnc = window NC (normally closed)



When the hysteresis function is set, the set point [SP] is defined first and then the reset point [rP] which must have a lower value. If only the set point is changed, the reset point remains constant.

5.5 Analogue function

UK

- The unit provides an analogue signal that is proportional to the volumetric flow quantity and the medium temperature.
- Within the measuring range the analogue signal is 4...20 mA.
- The measuring range is scalable:
 [ASP] determines at which measured value the output signal is 4 mA.
 [AEP] determines at which measured value the output signal is 20 mA.



Minimum distance between [ASP] and [AEP] = 25 % of the final value of the measuring range.

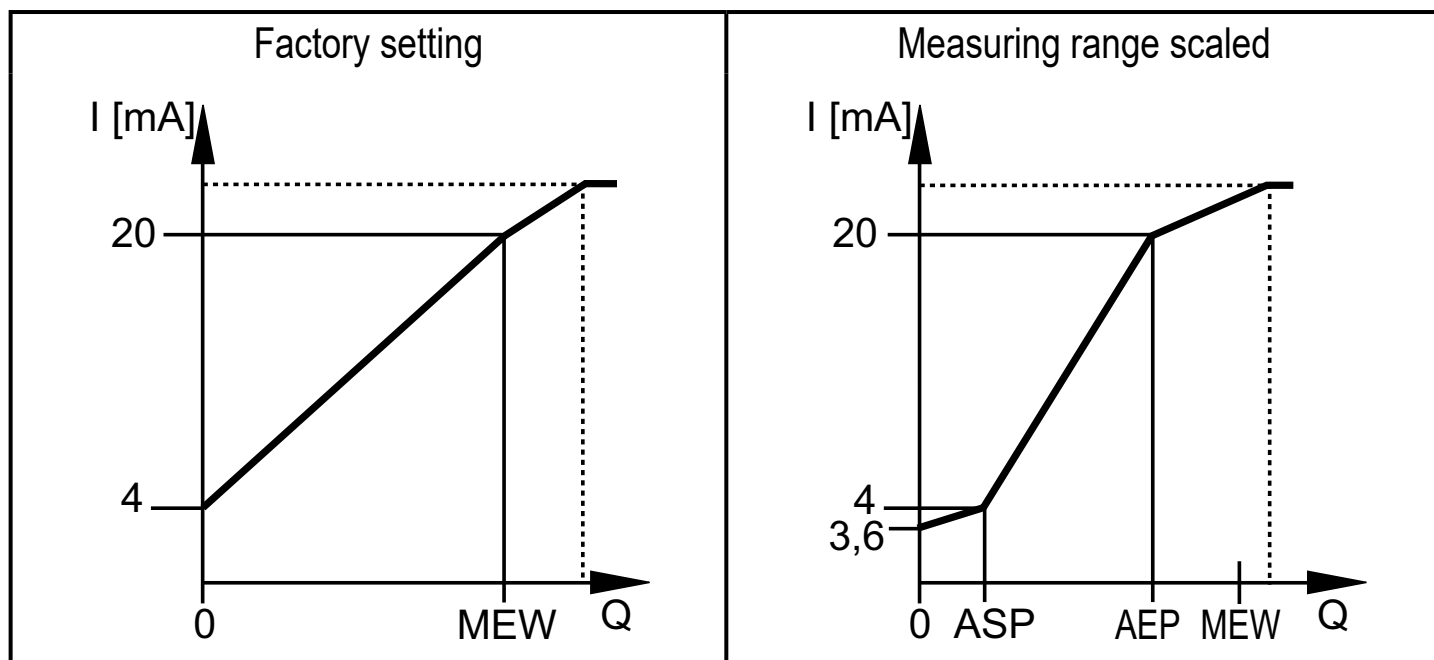

MEW = final value of the measuring range

Volumetric flow above the measuring range: output signal > 20 mA.

Volumetric flow below the measuring range: output signal between 3.6 and 4 mA.

6 Installation



- ▶ The rules and regulations for the installation and operation of compressed air equipment must be observed.
- ▶ Ensure that no pressure is applied to the installation during mounting.

6.1 Installation location



- Behind the cold dryer / near the load.
- If compressed air is fed into the main pipe through parallel pipes, the unit should be mounted in the main pipe.
- Installation after the maintenance unit is also possible (if oil is used for the loads, the units must be mounted before the oiler).
- Ensure sufficient clear space (min. 120 mm) for installation and removal of the sensor.

6.2 Installation conditions

To meet the specified measurement accuracy, the defined inlet and outlet pipe lengths must be adhered to:

- Inlet pipe length: 15 x pipe diameter.
- Outlet pipe length: 5 x pipe diameter.

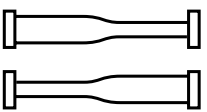
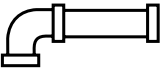
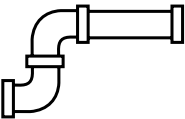
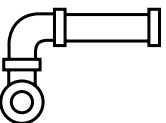
In case of disturbances on the inflow side additional calming sections (B) are recommended.

	changes of the pipe diameter	$B = 5 \times \text{pipe diameter (D)}$
	90° elbow	$B = 5 \times \text{pipe diameter (D)}$
	two 90° elbows, one plane	$B = 10 \times \text{pipe diameter (D)}$
	two 90° elbows, two planes	$B = 15 \times \text{pipe diameter (D)}$
	valve, slide	$B = 35 \times \text{pipe diameter (D)}$

6.3 Installation position

- Permitted installation positions: pipe length vertical, any position (fig. 1, 2), pipe length horizontal, unit vertical (fig. 3, 4), unit on side, pipe length left (fig. 5).
- Avoid the installation position in fig. 6 (unit on side, pipe length right). If the flow rate is low, the specified measurement accuracy cannot be adhered to.

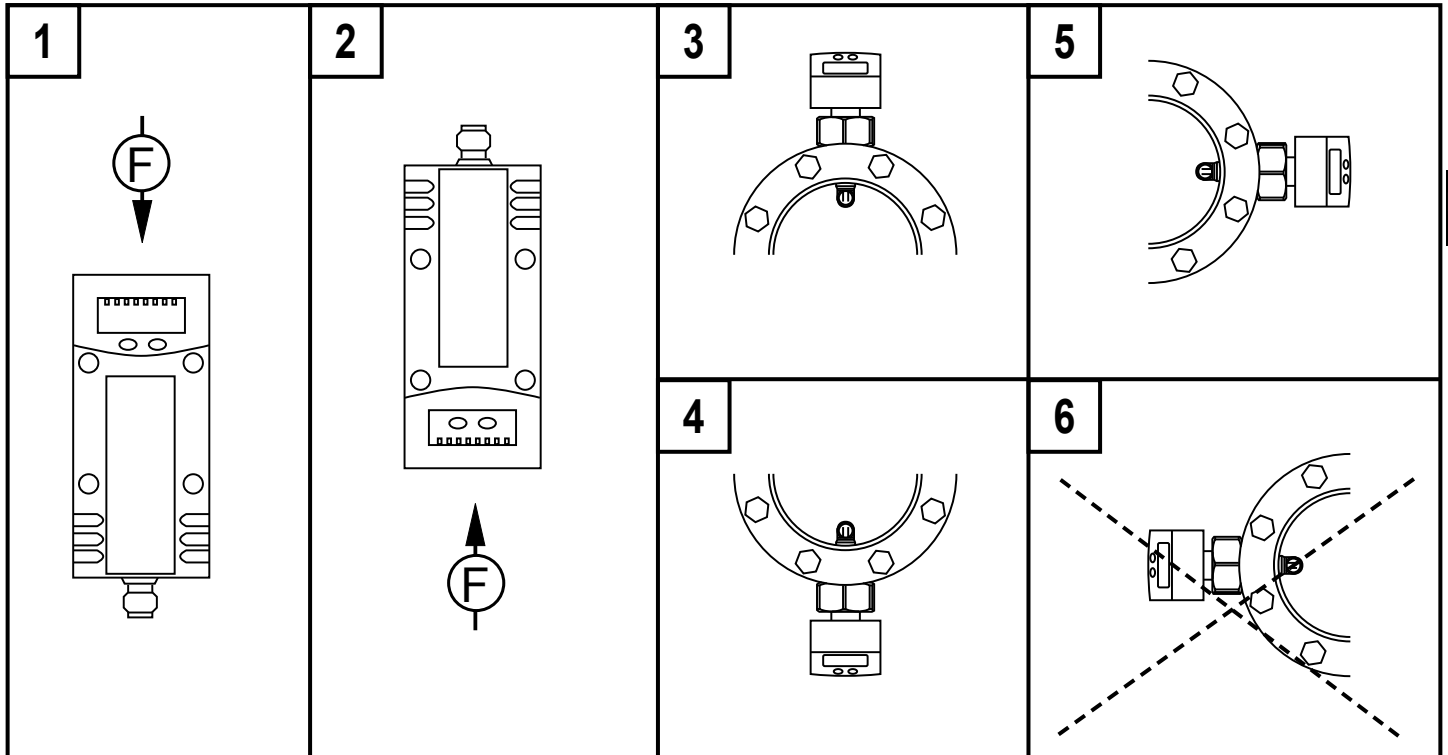

F = flow direction

6.4 Install the pipe section into the pipe

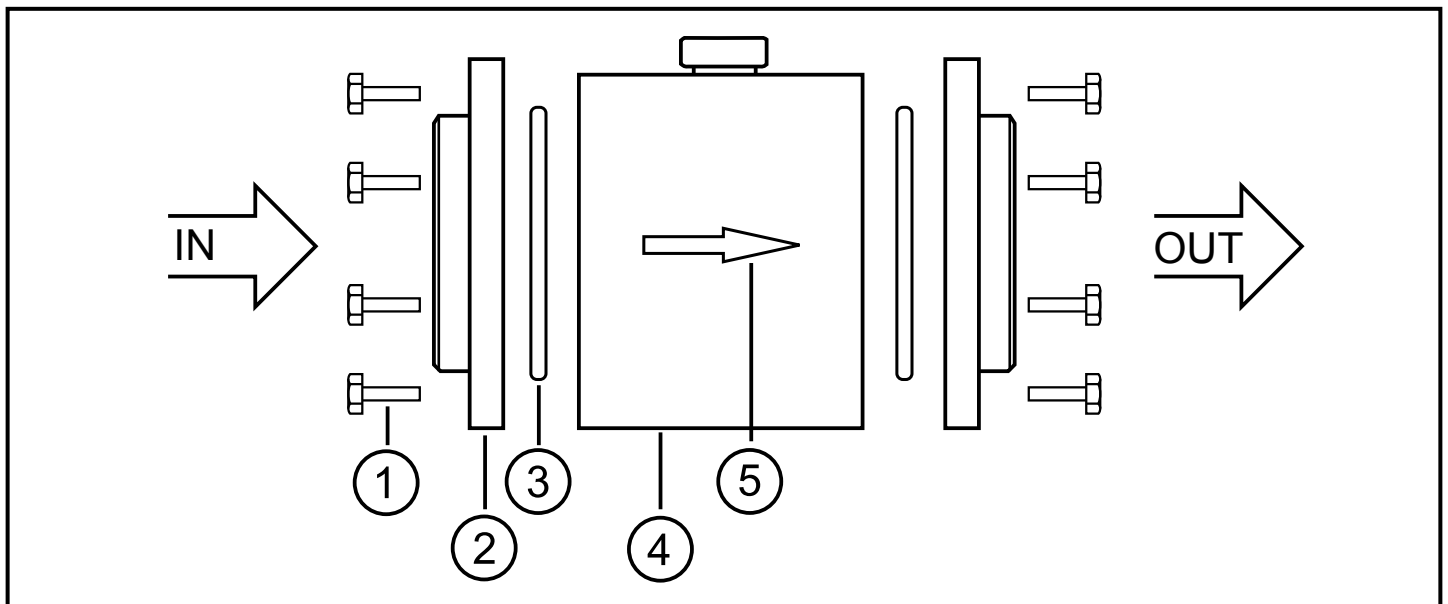

- ▶ Loosen the screws (1) on the flanges, remove the flanges (2) from the measuring section (4).
- ▶ Remove the seals (3) from the flange slots.
- ▶ Weld the flanges into the pipe.



The welding operation must be carried out by authorised personnel. The flanges must be welded without distortion. In order to prevent a dissimilar metal weld, pipe and flange must be of the same material.

After welding

- ▶ Let the pipe and flanges cool down.
- ▶ Remove any welding residues from the welding seams. Especially the inner surface of the pipe should be free from burrs so that the measurement accuracy is not impaired.
- ▶ Insert the seals into the flange slots. Note: The slot must be clean and free from welding residues.
- ▶ Insert the measuring length so that the flow direction and the arrow (5) show in the same direction.
- ▶ Insert the screws and tighten.

6.5 Insert the sensor into the pipe section

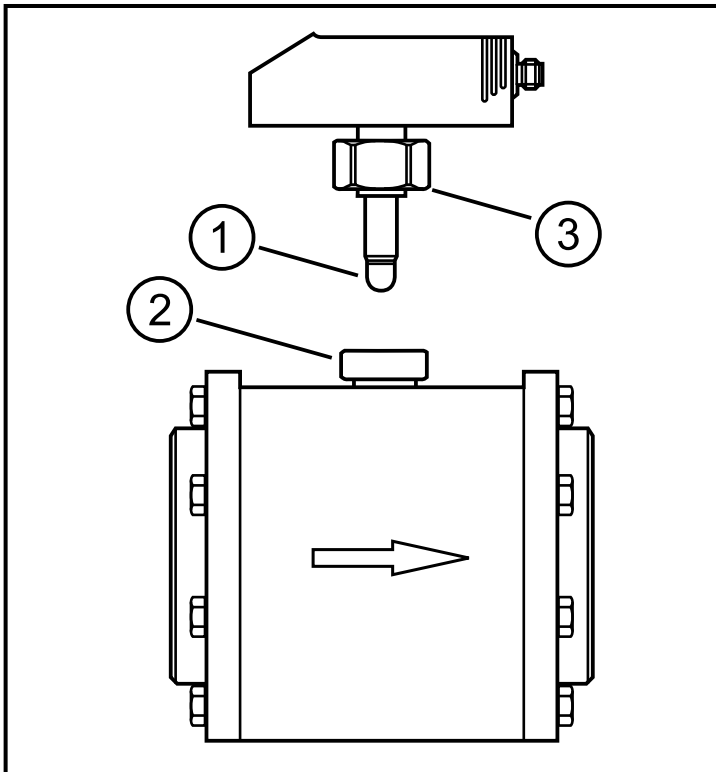

- ▶ Remove the protective cover from the measuring probe of the sensor (1).
- ▶ Insert the sensor into the measurement connection (2).
- ▶ Align the sensor: parallel to the pipe section, connector in the direction of the arrow on the pipe section.
- ▶ Tighten the nut (3). Tightening torque max. 50 Nm. When doing so, keep the position of the sensor.

7 Electrical connection



The unit must be connected by a qualified electrician.

The national and international regulations for the installation of electrical equipment must be adhered to.

Voltage supply according to EN 50178, SELV, PELV.

► Disconnect power.

► Connect the unit as follows:

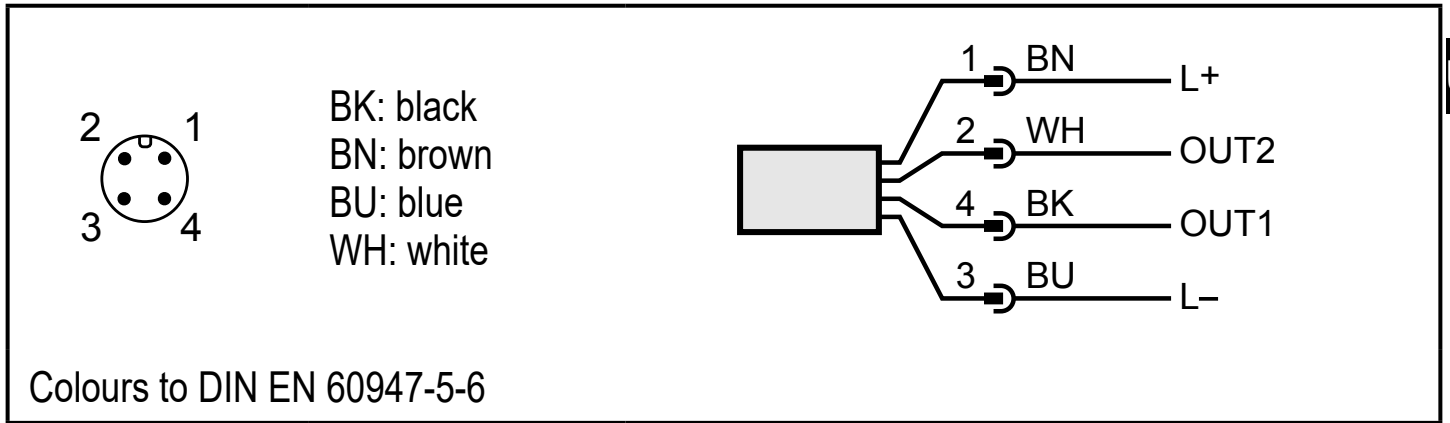

UK

Sample circuits:

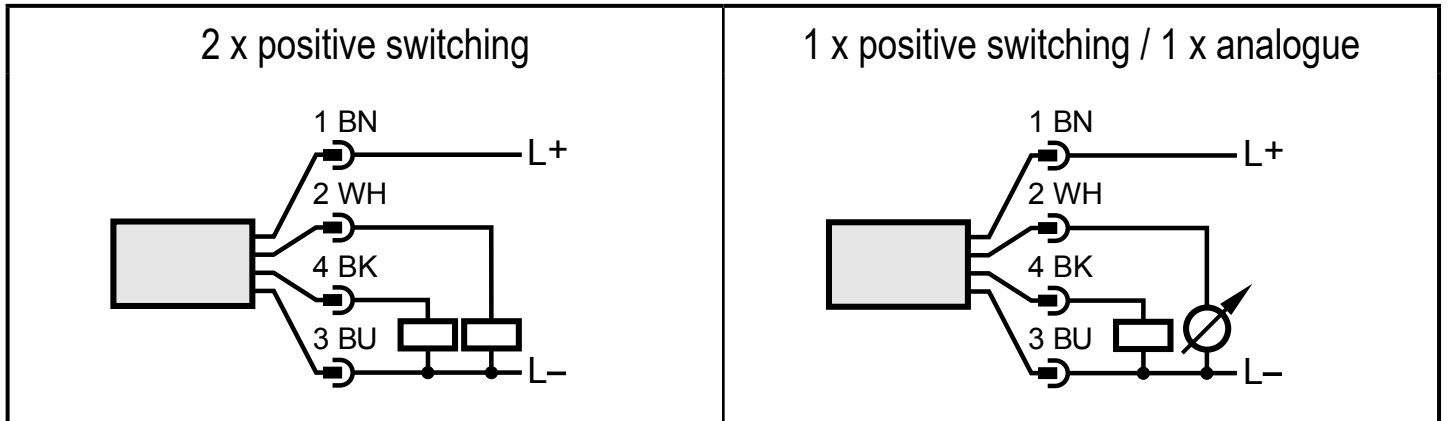

Pin 1	L+
Pin 3	L-
Pin 4 (OUT1)	<ul style="list-style-type: none"> • Switching signal: limit values for volumetric flow • Pulse signal: 1 pulse every time the defined volumetric flow quantity is reached. • Switching signal: quantity meter reached preset value
Pin 2 (OUT2)	<ul style="list-style-type: none"> • Switching signal: limit values for volumetric flow • Switching signal: limit values for temperature • Analogue signal for volumetric flow quantity • Analogue signal for temperature • Input for external counter reset signal

8 Operating and display elements

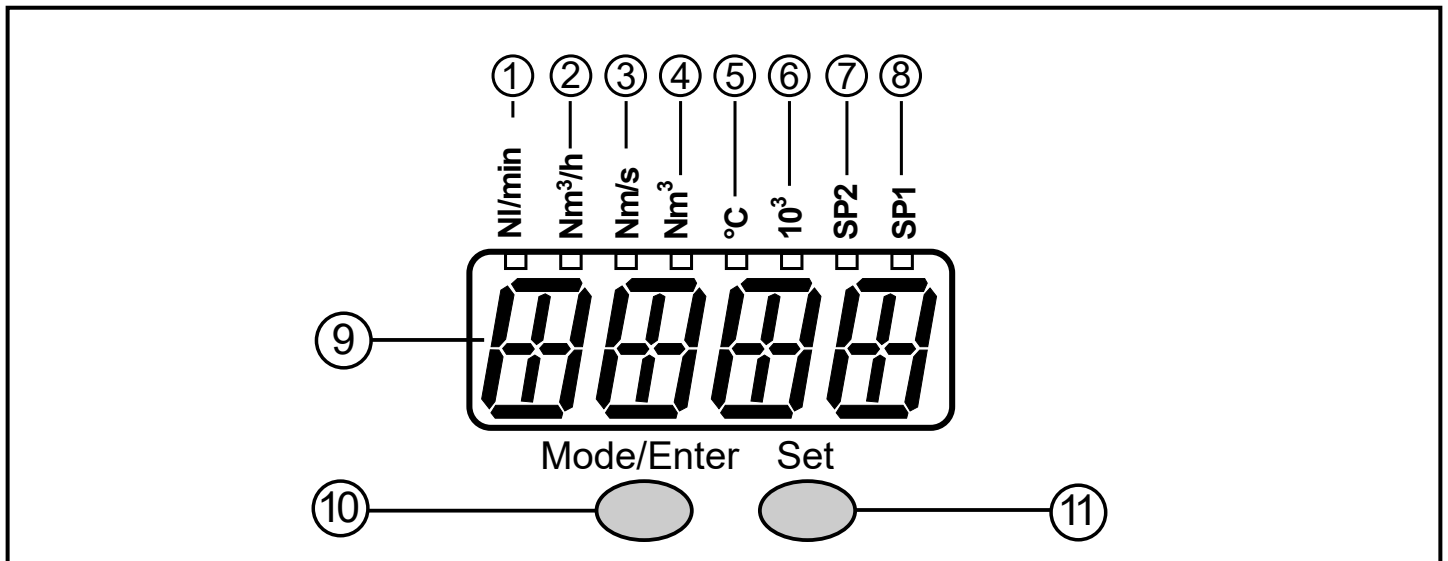

1 to 8: Indicator LEDs

- LED 1...6: process value in the indicated unit of measurement
- LED 7, LED 8: switching state of the corresponding output.

9: Alphanumeric display, 4 digits

- Current flow volume
- Current medium temperature
- Current consumed quantity (= meter reading)
- Consumed quantity (= meter reading) before the last reset
- Display of the parameters and parameter values

10: Mode/Enter button

- Selection of the parameters and acknowledgement of the parameter values.

11: Set pushbutton

- Setting of the parameter values (scrolling by holding pressed; incrementally by pressing once).
- Change of the display unit in the normal operating mode (Run mode).



For units \geq DN150 the displayed totaliser value has to be multiplied by the factor 1000.

9 Menu

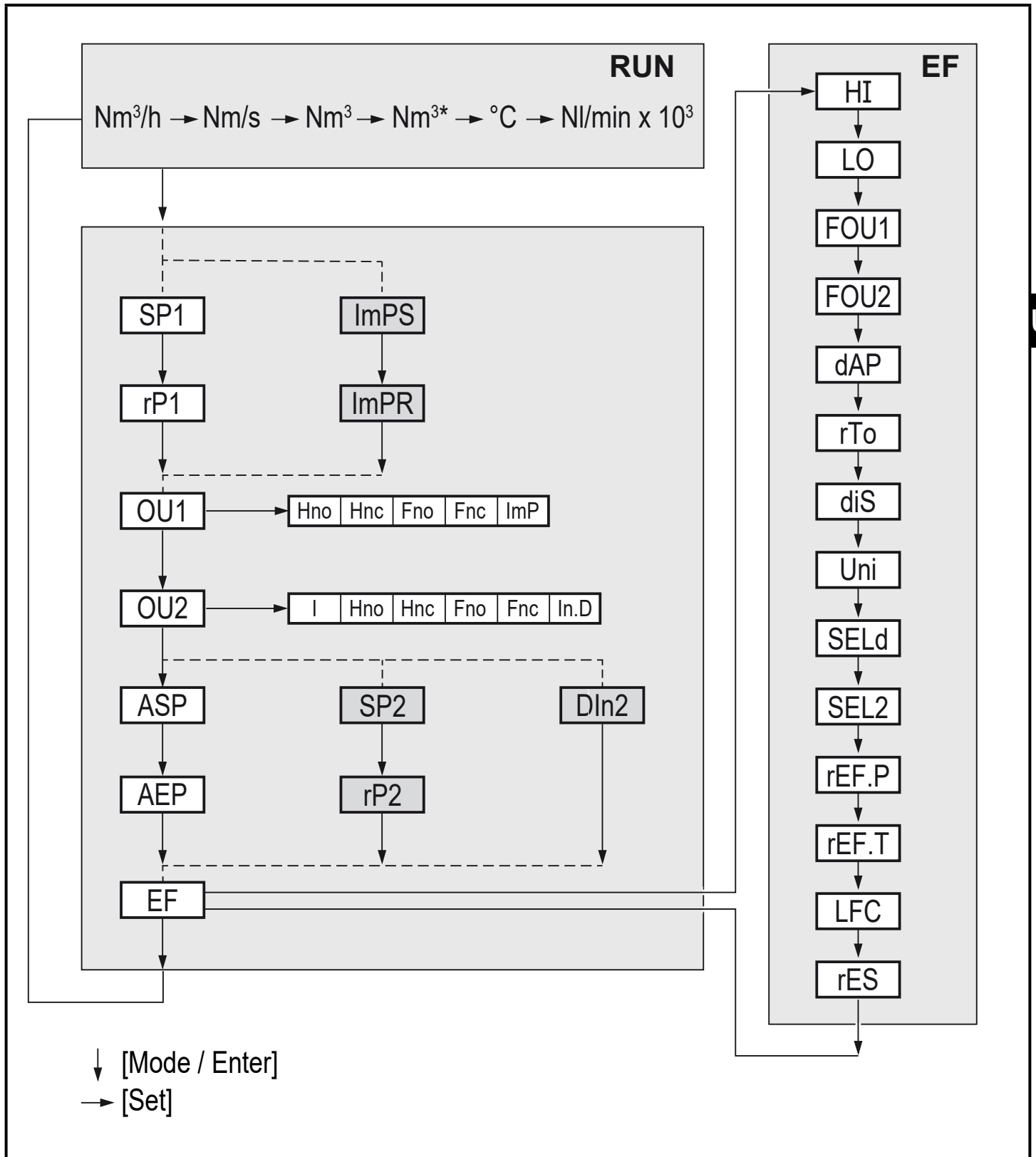

Nm^3 (LED is lit) = current meter reading
 Nm^{3*} (LED flashes) = stored meter reading

Explanation of the menu

ImPS	Pulse value (consumed quantity at which 1 pulse is delivered)
ImPR	Configuration of the output for consumed quantity monitoring: YES (pulse signal), no (switching signal)
SP1 / rP1	Upper / lower limit value for the volumetric flow at which OUT1 switches
OU1	Output function for OUT1 (volumetric flow): - Hno, Hnc, Fno, Fnc: switching signal for the limits - ImP: consumed quantity monitoring (totaliser function)
OU2	Output function for OUT2 (volumetric flow or temperature): - Hno, Hnc, Fno, Fnc: switching signal for the limits - I (current signal 4...20 mA) Input function for OUT2: - In.D: input for external meter reset signal
SP2 / rP2	Upper / lower limit value at which OUT2 switches.
ASP / AEP	Analogue start point / analogue end point for volumetric flow or temperature on OUT2
DIn2	Configuration of the input for external meter reset signal: HIGH, +EDG, LOW, -EDG
EF	Extended functions / opening of menu level 2
HI / LO	Maximum / minimum value memory for volumetric flow
FOU1 / FOU2	Behaviour of OUT1 / OUT2 in case of an internal fault: OU, On, OFF
dAP	Measured value damping: damping constant in seconds
rTo	Counter reset: manual reset / time-controlled reset
diS	Update rate and orientation of the display
Uni	Standard unit of measurement for volumetric flow: NI/min, Nm ³ /h, Nm/s
SEld	Standard measured variable of the display: FLOW (volumetric flow value), TEMP (medium temperature), TOTL (meter reading)
SEL2	Standard unit of measurement for evaluation by OUT2: FLOW (volumetric flow) or TEMP (temperature)
rEF.P	Standard pressure to which the measured and display values for volumetric flow refer
rEF.T	Standard temperature to which the measured and display values for volumetric flow refer
LFC	Low flow cut-off
rES	Restoring the factory settings

10 Parameter setting

During parameter setting the unit remains in the operating mode. It continues its monitoring function with the existing parameters until the parameter setting has been completed.

10.1 General parameter setting

3 steps must be taken for each parameter setting:

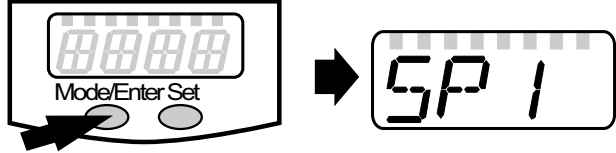
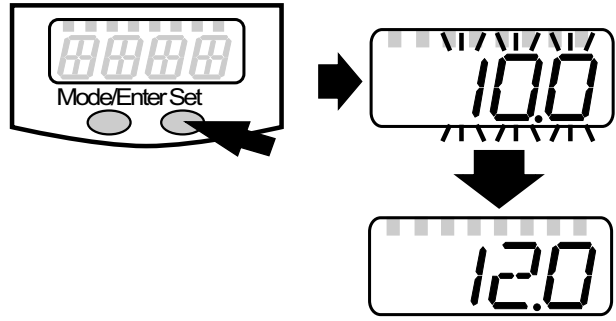
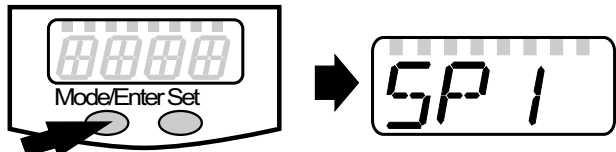
<p>1</p>	<p>Select parameter</p> <ul style="list-style-type: none"> ▶ Press [Mode/Enter] until the requested parameter is displayed. 	
<p>2</p>	<p>Setting of the parameter value</p> <ul style="list-style-type: none"> ▶ Press [Set] and keep it pressed. > Current setting value of the parameter flashes for 5 s. > After 5 s: setting value is changed: incrementally by pressing the button once or continuously by keeping the button pressed. 	
<p>Numerical values are incremented continuously. To reduce the value: let the display move to the maximum setting value. Then the cycle starts again at the minimum setting value.</p>		
<p>3</p>	<p>Acknowledge parameter value</p> <ul style="list-style-type: none"> ▶ Press [Mode/Enter] briefly. > The parameter is displayed again. The new setting value is stored. 	
<p>Setting of other parameters</p> <ul style="list-style-type: none"> ▶ Start again with step 1. 		
<p>Finishing the parameter setting</p> <ul style="list-style-type: none"> ▶ Press [Mode/Enter] several times until the current measured value is displayed or wait for 15 s. > The unit returns to the operating mode. 		

UK

- Change from menu level 1 to menu level 2:

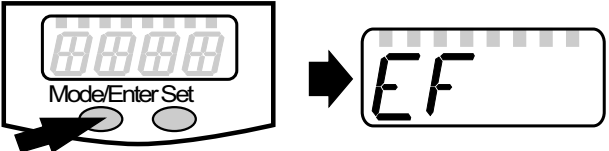
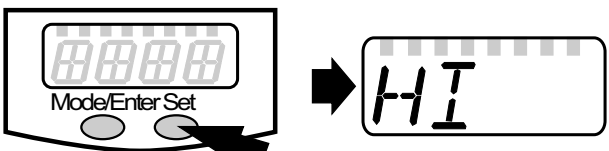
<ul style="list-style-type: none"> ▶ Press [Mode/Enter] until [EF] is displayed. 	
<ul style="list-style-type: none"> ▶ Press [Set] briefly. > The first parameter of the submenu is displayed (here: [HI]). 	

- Locking / unlocking

The unit can be locked electronically to prevent unintentional settings.

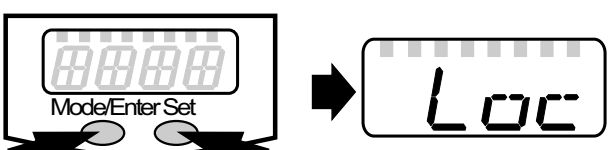
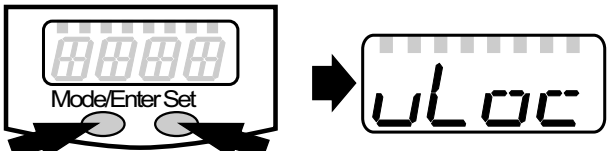
<ul style="list-style-type: none"> ▶ Make sure that the unit is in the normal operating mode. ▶ Press [Mode/Enter] + [Set] for 10 s. > [Loc] is displayed. 	
<p>During operation: [LOC] is briefly displayed if you try to change parameter values.</p>	
<p>For unlocking:</p> <ul style="list-style-type: none"> ▶ Press [Mode/Enter] + [Set] for 10 s. > [uLoc] is displayed. 	

On delivery: unlocked.

- Timeout:

If no button is pressed for 15 s during parameter setting, the unit returns to the operating mode with unchanged values.

10.2 Settings for volumetric flow monitoring

10.2.1 Limit monitoring volumetric flow (OUT1)

- ▶ Select [OU1] and set the switching function: Hno, Hnc, Fno or Fnc.
- ▶ Select [SP1] and set the upper limit of the volumetric flow.
- ▶ Select [rP1] and set the lower limit of the volumetric flow.

10.2.2 Limit monitoring volumetric flow (OUT2)

- ▶ Select [SEL2] and set FLOW.
- ▶ Select [OU2] and set the switching function: Hno, Hnc, Fno or Fnc.
- ▶ Select [SP2] and set the upper limit of the volumetric flow.
- ▶ Select [rP2] and set the lower limit of the volumetric flow.

10.2.3 Analogue output flow rate (OUT2)

- ▶ Select [SEL2] and set FLOW.
- ▶ Select [OU2] and set the analogue function: I (4...20 mA).
- ▶ Select [ASP2] and set the volumetric flow value at which the minimum current value is provided.
- ▶ Select [AEP2] and set the volumetric flow value at which the maximum current value is provided.

10.3 Settings for consumed quantity monitoring

10.3.1 Quantity monitoring by pulse output (OUT1)

- ▶ Select [OU1] and set ImP.
- ▶ Select [ImPR] and set YES.
- ▶ Select [ImPS] and set the volumetric flow quantity at which 1 pulse is provided.

10.3.2 Quantity monitoring by preset counter (OUT1)

- ▶ Select [OU1] and set ImP.
- ▶ Select [ImPR] and set no.
- ▶ Select [ImPS] and set the volumetric flow quantity at which output 1 switches.

10.3.3 Manual counter reset

- ▶ Select [rTo] and set rES.T.
- > The counter is reset to zero.

10.3.4 Time-controlled counter reset

- ▶ Select [rTo] and set the requested value (intervals of hours, days or weeks).
- > The counter is reset automatically with the value now set.

10.3.5 Deactivation of the counter reset

- ▶ Select [rTo] and set OFF.
- > The meter is only reset after overflow (= factory setting).

10.3.6 Counter reset using an external signal

- ▶ Select [OU2] and set In.D.
- ▶ Select [DIn2] and set the counter reset signal:
 - HIGH = reset for high signal
 - LOW = reset for low signal
 - +EDG = reset for rising edge
 - EDG = reset for falling edge

10.4 Settings for temperature monitoring

10.4.1 Limit monitoring temperature (OUT2)

- ▶ Select [SEL2] and set TEMP.
- ▶ Select [OU2] and set the switching function: Hno, Hnc, Fno or Fnc.
- ▶ Select [SP1] and set the upper temperature limit.
- ▶ Select [rP2] and set the lower temperature limit.

10.4.2 Analogue output temperature (OUT2)

- ▶ Select [SEL2] and set TEMP.
- ▶ Select [OU2] and set the analogue function: I (4...20 mA).
- ▶ Select [ASP2] and set the temperature value at which the minimum current value is provided.
- ▶ Select [AEP2] and set the temperature value at which the maximum current value is provided.

10.5 User settings (optional)

10.5.1 Standard unit of measurement for volumetric flow

- ▶ Select [uni] and set the unit of measurement.



The setting only has an effect on the volumetric flow value. The consumed quantity (meter reading) is automatically displayed in the unit of measurement providing the highest accuracy.

10.5.2 Standard display

- ▶ Select [SEld] and define the standard unit of measurement
FLOW = display shows the current volumetric flow value in the standard unit of measurement.
TOTL = display shows the current meter reading in the unit providing the highest accuracy.
TEMP = the current medium temperature in °C is displayed.
- ▶ Select [diS] and set the update rate and orientation of the display:
d1 = update of the measured values every 50 ms.
d2 = update of the measured values every 200 ms.
d3 = update of the measured values every 600 ms.
rd1, rd2, rd3 = display like d1, d2, d3; rotated by 180.
OFF = the display is switched off in the operating mode. The LEDs remain active even if the display is deactivated. Error messages are displayed even if the display is deactivated.

10.5.3 Measured value damping

- ▶ Select [dAP] and set the damping constant in seconds (τ value 63 %).

10.5.4 Error behaviour of the outputs

- ▶ Select [FOU1] and set the value:
 - On = Output 1 switches ON in case of a fault.
 - OFF = Output 1 switches OFF in case of an error.
 - OU = Output 1 switches irrespective of the fault as defined with the parameters.
- ▶ Select [FOU2] and set the value:
 1. Switching output:
 - On = Output 2 switches ON in case of a fault.
 - OFF = Output 2 switches OFF in case of a fault.
 - OU = Output 2 switches irrespective of the fault as defined with the parameters.
 2. Analogue output:
 - On = The analogue signal goes to the upper fault value.
 - OFF = The analogue value goes to the lower fault value.
 - OU = The analogue signal corresponds to the measured value.

10.5.5 Setting of the standard pressure

- ▶ Select [rEF.P] and set the requested standard pressure.

10.5.6 Setting of the standard temperature

- ▶ Select [rEF.T] and set the requested standard temperature.

10.5.7 Low flow cut-off

- ▶ Select [LFC] and set the limit.

10.6 Service functions

10.6.1 Read min/max values

Read minimum or maximum measured values:

- ▶ Select HI or LO
HI = maximum volumetric flow, LO = minimum volumetric flow

Delete memory:

- ▶ Select HI or LO.
- ▶ Press and hold [Set] until [----] is displayed.
- ▶ Briefly press [Mode/Enter].



It makes sense to delete the memories as soon as the unit operates under normal operating conditions for the first time.

10.6.2 Restoring the factory settings

- ▶ Select [rES].
- ▶ Press and hold [Set] until [----] is displayed.
- ▶ Briefly press [Mode/Enter].

11 Operation

Correct operation and compliance with the measurement accuracy can only be ensured if the environmental conditions specified in the "Technical data" are adhered to. Ensure that the maximum pressure range, measuring range and permitted operating temperature are not exceeded.

After power on and expiry of the power-on delay time (approx. 0.5 s) the unit is in the Run mode (= normal operating mode). It carries out its measurement and evaluation functions and generates output signals according to the set parameters.

- Operating indications → 8 Operating and display elements.
- During the power-on delay time the outputs are switched as programmed: ON for NO function (Hno / Fno), OFF for NC function (Hnc / Fnc).
- If output 2 is configured as analogue output, the output signal is at the final value of the measuring range during the power-on delay time.

11.1 Reading of the set parameters

- ▶ Press [Mode/Enter] until the requested parameter is displayed.

- ▶ Press [Set] briefly.
- > The unit displays the corresponding parameter value. After about 15 s it again displays the parameter, then it returns to the Run mode.

11.2 Changing the display unit in the Run mode

- ▶ Press [Set] briefly in the Run mode. Press the pushbutton to move to the next display unit.
- > The unit displays the current measured value for approx. 15 s, the corresponding LED lights.

11.3 Error indications

UK

[SC1]	Short circuit in OUT1.*
[SC2]	Short circuit in OUT2.*
[SC]	Short circuit in both outputs.*
[OL]	Measured value > 120 % of the final value of the measuring range.
[Err]	Flashing: error in the measuring probe.

*The output concerned is switched off as long as the short circuit exists. These messages are displayed even if the display is switched off.

11.4 General operating conditions

- From time to time check the measuring probes visually for build-up. Removal of the sensor: Loosen the coupling nut, remove the sensor from the measuring hole (figure in → 6.5). Installation → 6.5.
- If necessary, clean them at regular intervals. To do so, use a suitable cleaning liquid (e.g. alcoholic solution).
- Avoid mechanical damage to the measuring probes.

12 Technical data and scale drawing

Technical data and scale drawing at www.ifm.com.