

ifm electronic

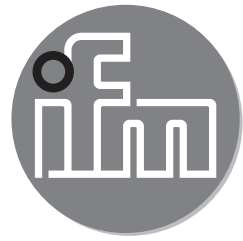

Operating instructions  
Through-beam sensor

**efector200<sup>®</sup>**

**O6E3 / O6S3**

**UK**

O6E300 / 02 11 / 2015

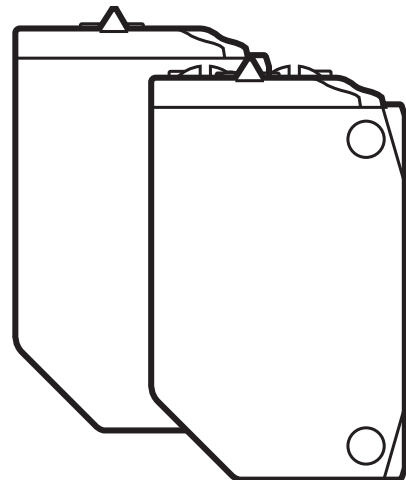

# 1 Preliminary note

## 1.1 Symbols used

- ▶ Instruction
- > Reaction, result
- [...] Designation of pushbuttons, buttons or indications
- Cross-reference



Important note

Non-compliance can result in malfunctions or interference.

## 2 Functions and features

The through-beam sensor detects objects and materials without contact and indicates their presence by a switching signal.

## 3 Installation

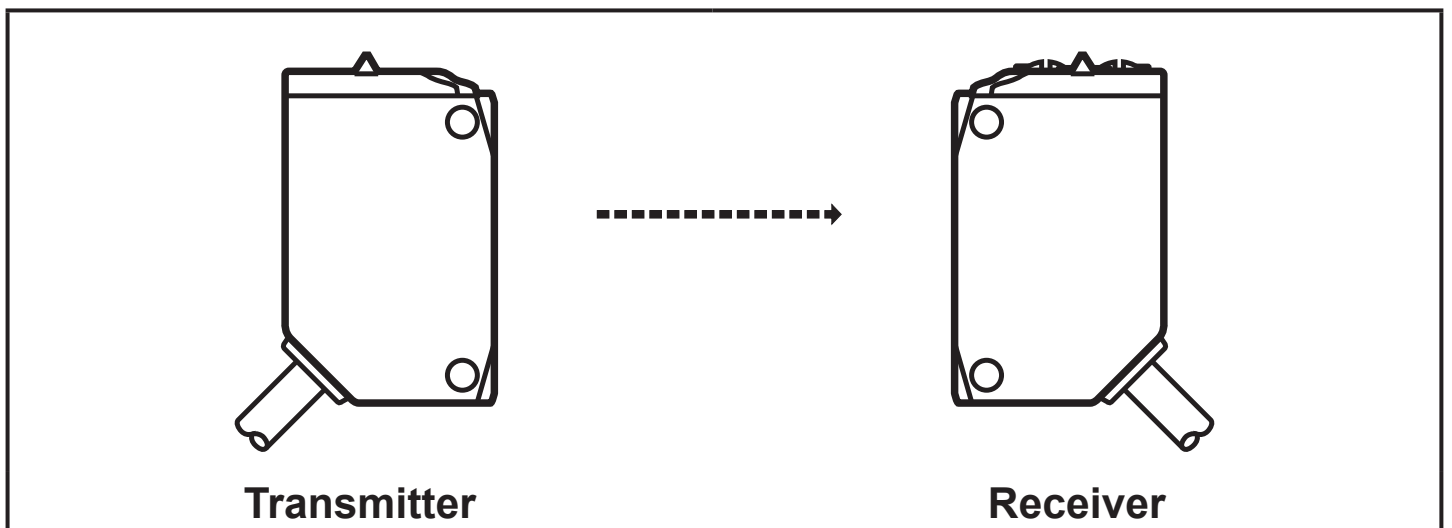

- ▶ Install the receiver (O6E...) and secure it to a bracket.
- ▶ Align the transmitter (O6S...) to the receiver and fix it.

Maximum range only with accurate alignment.

## 4 Operating and display elements

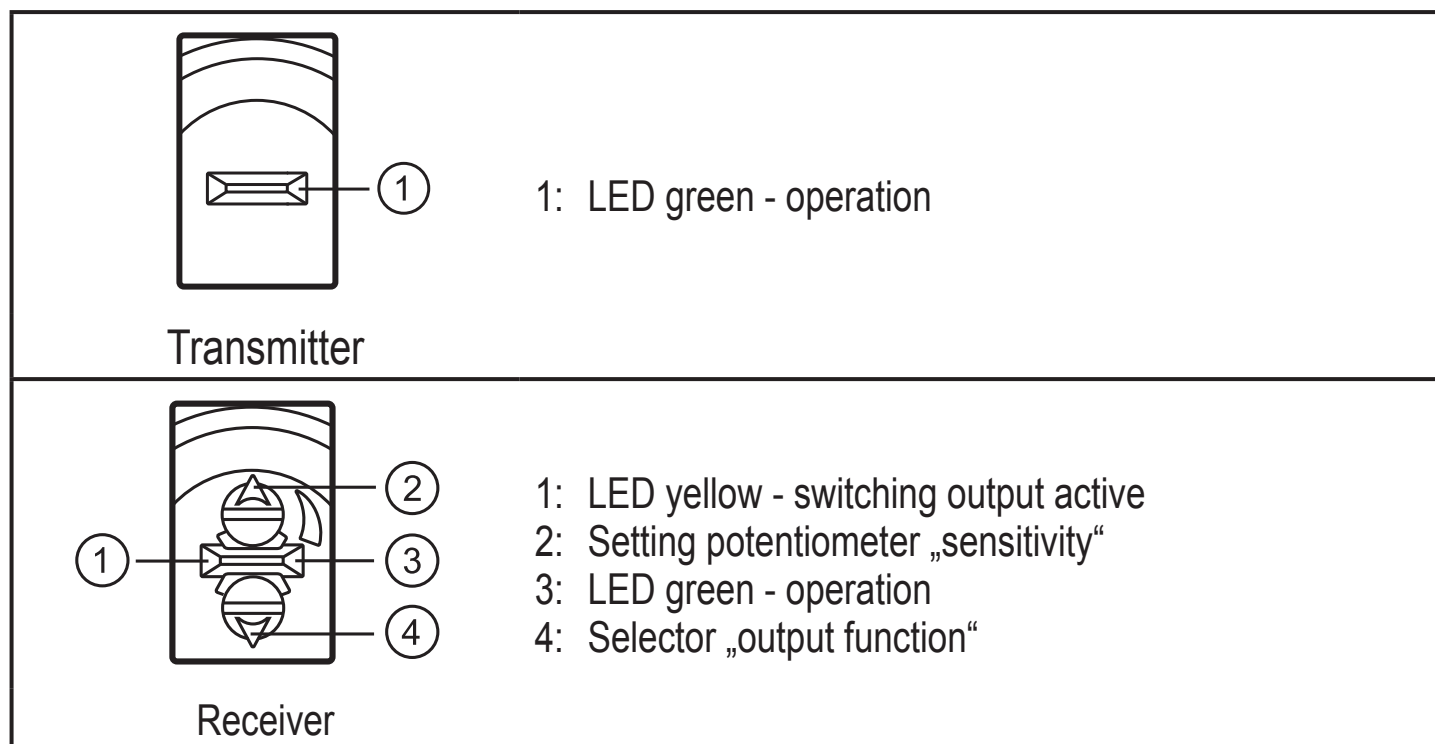

UK

### 4.1 Stability indication

The green LED is lit when the supply voltage is applied and the sensor signal is stable.

	stable signal	switch point	stable signal
Light-on mode			
LED green	on	off	on
LED yellow	on	on	off
Dark-on mode			
LED green	on	off	on
LED yellow	off	off	on

# 5 Electrical connection



The unit must be connected by a qualified electrician.

- ▶ The national and international regulations for the installation of electrical equipment must be adhered to.
- ▶ Ensure voltage supply to EN 50178.

▶ Disconnect power.

▶ Connect the unit as follows:

## 5.1 Transmitter

### Connector M12 pigtail

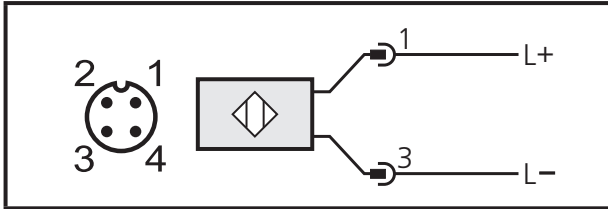

### Cable \*

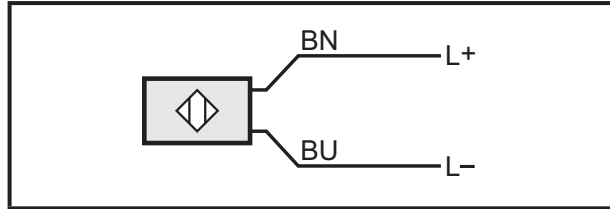

### Connector M8 3-pin

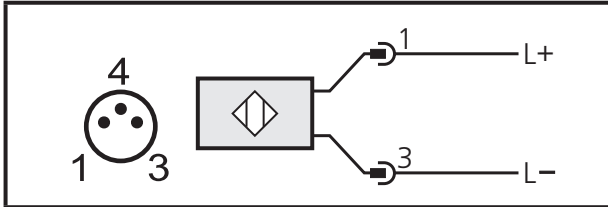

### Connector M8 4-pin

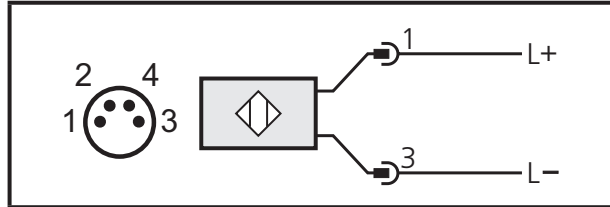

\* Core colours: BN = brown, BU = blue, BK = black

## 5.2 Receiver

### 5.2.1 PNP

#### Connector M12 pigtail

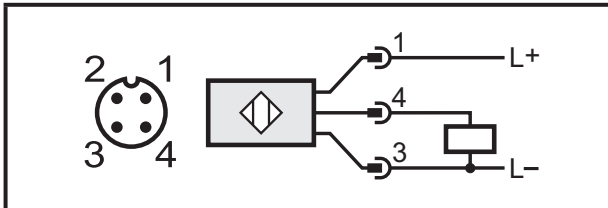

#### Cable \*

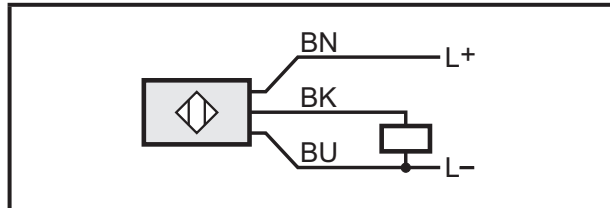

#### Connector M8 3-pin

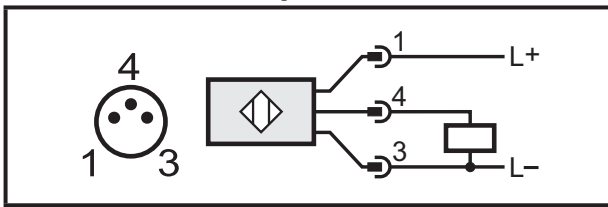

#### Connector M8 4-pin

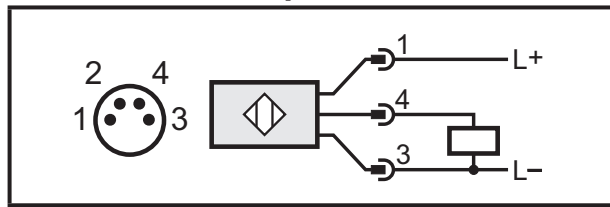

\* Core colours: BN = brown, BU = blue, BK = black

## 5.2.2 NPN

### Connector M12 pigtail

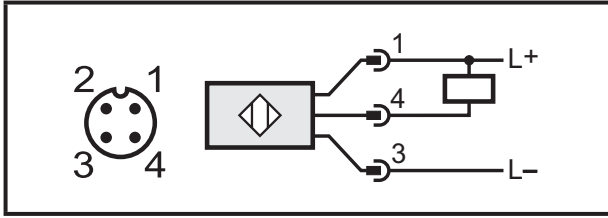

### Cable \*

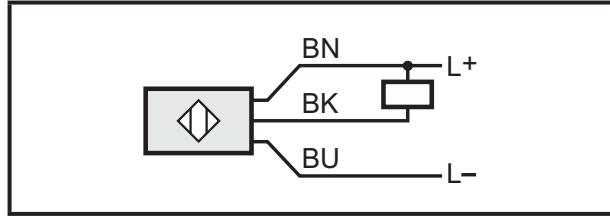

### Connector M8 3-pin

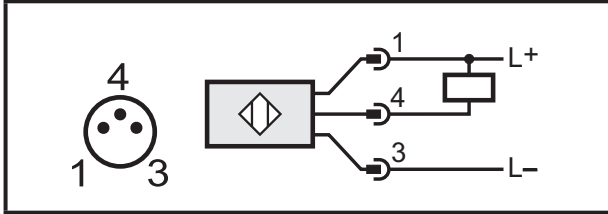

### Connector M8 4-pin

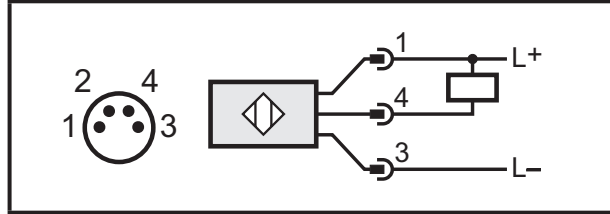

\* Core colours: BN = brown, BU = blue, BK = black

## 6 Settings

### 6.1 Set the output function

<p>Receiver</p>	<ul style="list-style-type: none"><li>▶ Setting D: dark-on mode</li><li>▶ Setting L: light-on mode</li></ul>
-----------------	--

### 6.2 Set the sensitivity

<p>Receiver</p>	<ul style="list-style-type: none"><li>▶ Increase sensitivity: turn the setting screw of the potentiometer clockwise.</li><li>▶ Decrease sensitivity: turn the setting screw of the potentiometer anti-clockwise.</li></ul>
-----------------	--

## 7 Operation

- ▶ Check whether the unit operates correctly.
- > The green LED is lit when the sensor is ready for operation.
- > Dark-on mode: the output is switched / the yellow LED is lit when an object is detected.
- > Light-on mode: the output is switched / the yellow LED is lit when no object is detected.

## 8 Maintenance, repair, disposal

- ▶ Keep the lens of the sensor free from soiling.
- ▶ For cleaning do not use any solvents or cleaning agents which could damage the plastic parts.
- ▶ After use dispose of the unit in an environmentally friendly way in accordance with the applicable national regulations.

Faulty sensors must only be repaired by the manufacturer.

Technical data and further information at unter <a href="http://www.ifm.com">www.ifm.com</a>
--