



Operating instructions

RFID UHF antennas **Low range / ultra-low range** **Mid range / short mid range** **Wide range**

UK

- ANT805**
- ANT810**
- ANT815**
- ANT820**
- ANT830**
- ANT860**
- ANT910**
- ANT920**
- ANT930**
- ANT960**

706385 / 01 06 / 2019

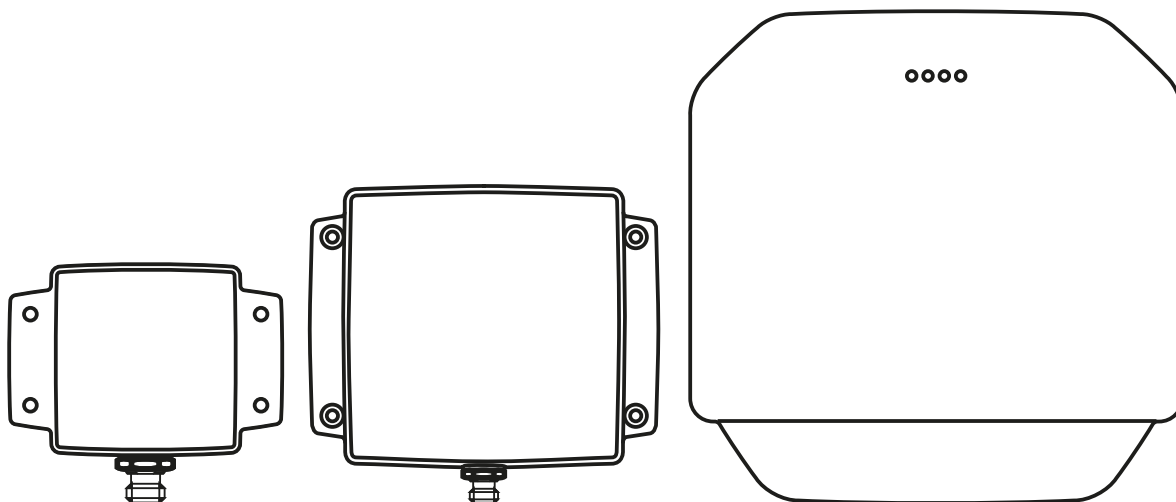

Content

1	Preliminary note	3
1.1	Symbols used	3
2	Safety instructions	3
2.1	General	3
2.2	Target group	3
2.3	Electrical connection	4
2.4	Tampering with the device	4
2.5	Environmental conditions	4
3	Product description	5
3.1	Low-range antennas	5
3.2	Mid-range antennas	5
3.3	Wide-range antennas	6
3.4	Antenna type according to reading range and transponder shape	7
4	Reading range and selectivity	9
4.1	Antenna allocation according to tag types	9
4.2	Reading range	9
4.3	Selectivity	10
4.4	Selectivity and reading range of the low-range antennas	10
5	Conformity with standards	11
6	Installation	13
6.1	Installation location	13
6.2	Laying of cables	14
7	Typical applications	15
7.1	Pharmaceutical industry	15
7.2	Access systems	15
7.3	Automation industry	15
7.4	Other applications for mid-range antennas	15
8	Abbreviations	16
9	Approvals	16
10	Maintenance, repair and disposal	16



1 Preliminary note

This document is intended for specialists. These specialists are people who are qualified by their appropriate training and their experience to see risks and to avoid possible hazards that may be caused during operation or maintenance of the device. The document contains information about the correct handling of the device.

Read this document before use to familiarise yourself with operating conditions, installation and operation. Keep this document during the entire duration of use of the device.

UK

1.1 Symbols used

- ▶ Instructions
- > Reaction, result
- [...] Designation of keys, buttons or indications
- Cross-reference
-  Important note
Non-compliance may result in malfunction or interference.
-  Information
Supplementary note

2 Safety instructions

2.1 General

These instructions are an integral part of the device. They contain texts and figures concerning the correct handling of the device and must be read before installation or use.

Observe the operating instructions. Non-observance of the instructions, operation which is not in accordance with use as prescribed below, wrong installation or incorrect handling can seriously affect the safety of operators and machinery.

2.2 Target group

These instructions are intended for authorised persons according to the EMC and low-voltage directives. The device must only be installed, connected and put into operation by a qualified electrician.

2.3 Electrical connection

Disconnect the device externally before handling it.

The connection pins may only be supplied with the signals indicated in the technical data and/or on the device label and only the approved accessories of ifm may be connected.

2.4 Tampering with the device

In case of malfunctions or uncertainties please contact the manufacturer. Any tampering with the device can seriously affect the safety of operators and machinery. This is not permitted and leads to the exclusion of any liability and warranty claims.

2.5 Environmental conditions

Do not place the device in the vicinity of heatings, do not expose it to direct sunlight and do not operate it in wet environments. No objects with open flames must be placed onto the device. Protect the device against moisture, falling water drops and splashing water. Observe the environmental conditions indicated in the technical data sheet.

There is a risk of fire in unsuitable environmental conditions.

3 Product description

The ifm RFID antennas consist of several UHF antennas which can meet the requirements of almost any RFID application. The antennas are divided into three product lines with regard to their reading range: low-range, mid-range and wide-range antennas.

3.1 Low-range antennas

With dimensions of 90 x 63 mm the ANT810 / ANT910 low-range antennas have a high field concentration in the near field and an extremely reduced antenna gain in the far field. These features ensure that the antennas achieve ranges up to 10 cm with a typical selectivity of 5 cm.

In addition to the low-range antennas there is the ANT805 ultra-low-range antenna. The ultra-low-range antenna was designed to read dipole-shaped tags ("far-field tags") at a very limited distance. This antenna can also activate loop-shaped tags ("near-field tags") up to 3 cm. The low-range antennas were developed for larger ranges so that they are in particular suitable for near-field tags. The antenna allocation according to the reading range and tag shape is outlined in chapter 3.4.



3.2 Mid-range antennas

The ANT815 / ANT820 / ANT920 mid-range antennas were designed for applications in the range between near and far field. Special importance was placed on a compact design to ensure integration into space-limited environments. With dimensions of 156 x 126 reading ranges of more than 2 m are nevertheless possible. Mid-range antennas also have an increased selectivity at lower read distances as compared to conventional antennas. That means the mid-range antennas are suitable for use in the transition range with different tags.



3.3 Wide-range antennas

For the conventional far-field applications with reading ranges up to 10 m ifm offers the following wide-range antennas:







- ANT830 / ANT930 with a full width at half maximum of 70°,
- ANT860 / ANT960 with a full width at half maximum of 65°.

The circular polarisation usually required for UHF applications was significantly improved as compared to the antennas available on the market. The new versions typically attain an axial ratio of 1 dB that is used as reference for circular polarisation. The value common on the market, if specified at all, is approx. 3 dB.

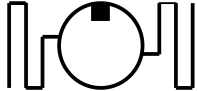
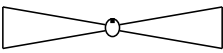

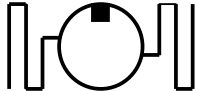
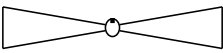
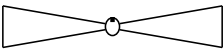
The improved circularity leads to a considerably reduced dependence of the read results on the tag's position or alignment. Great importance was also placed on the front-to-back ratio of the antennas to reduce the influence of the close environment on the antenna properties. All antennas have an extremely high protection rating which guarantees their use in any industrial environment.

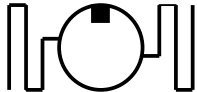
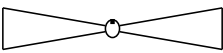
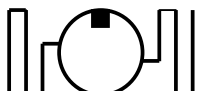
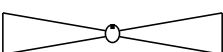
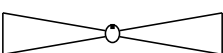
3.4 Antenna type according to reading range and transponder shape

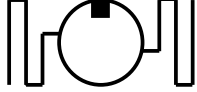
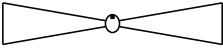
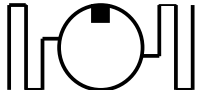
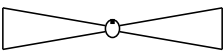
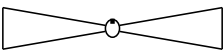
Antenna type	Reading range	Tag type Loop	Tag type Hybrid	Tag type Dipole-type
ANT805	0-10 cm			
ANT810 ANT910	0-10 cm			
ANT815	0-10 cm			
	10-100 cm			
ANT820 ANT920	10-30 cm			
	30-100 cm			
	> 100 cm			
ANT830 ANT930 ANT860 ANT960	10-30 cm			
	30-200 cm			
	> 200 cm			

UK

The correct combination of antenna and tag is essential for every RFID application. The correct selection ensures a high reading rate and reliable operation of the system.

The low-range (ANT810/ANT910) and ultra-low-range antennas (ANT805) can read the loop-shaped and dipole-type tags up to 10 cm and have a very well-defined reading range.

The short-mid-range antenna (ANT815) can activate hybrid-type tags up to 10 cm and dipole-type tags up to 100 cm.

The mid-range antennas (ANT820/ANT920) can activate loop-shaped tags up to 30 cm, the hybrid-type tags up to 100 cm and the dipole-type tags up to 2 m.

The wide-range antennas (ANT830/ANT930/ANT860/ANT960) can read loop-shaped tags up to 30 cm, the hybrid-type tags up to 200 cm and the dipole-type tags up to several metres.

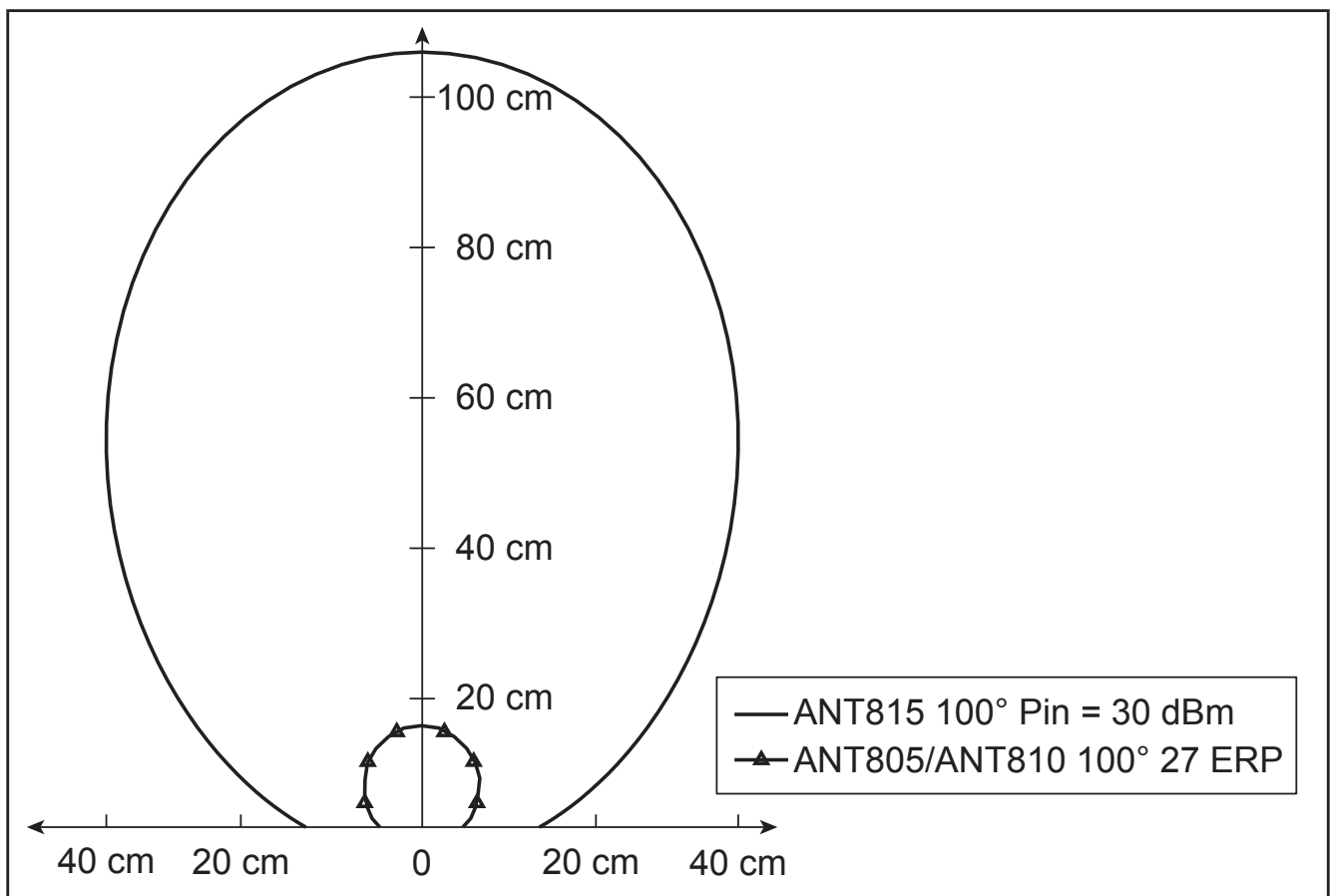
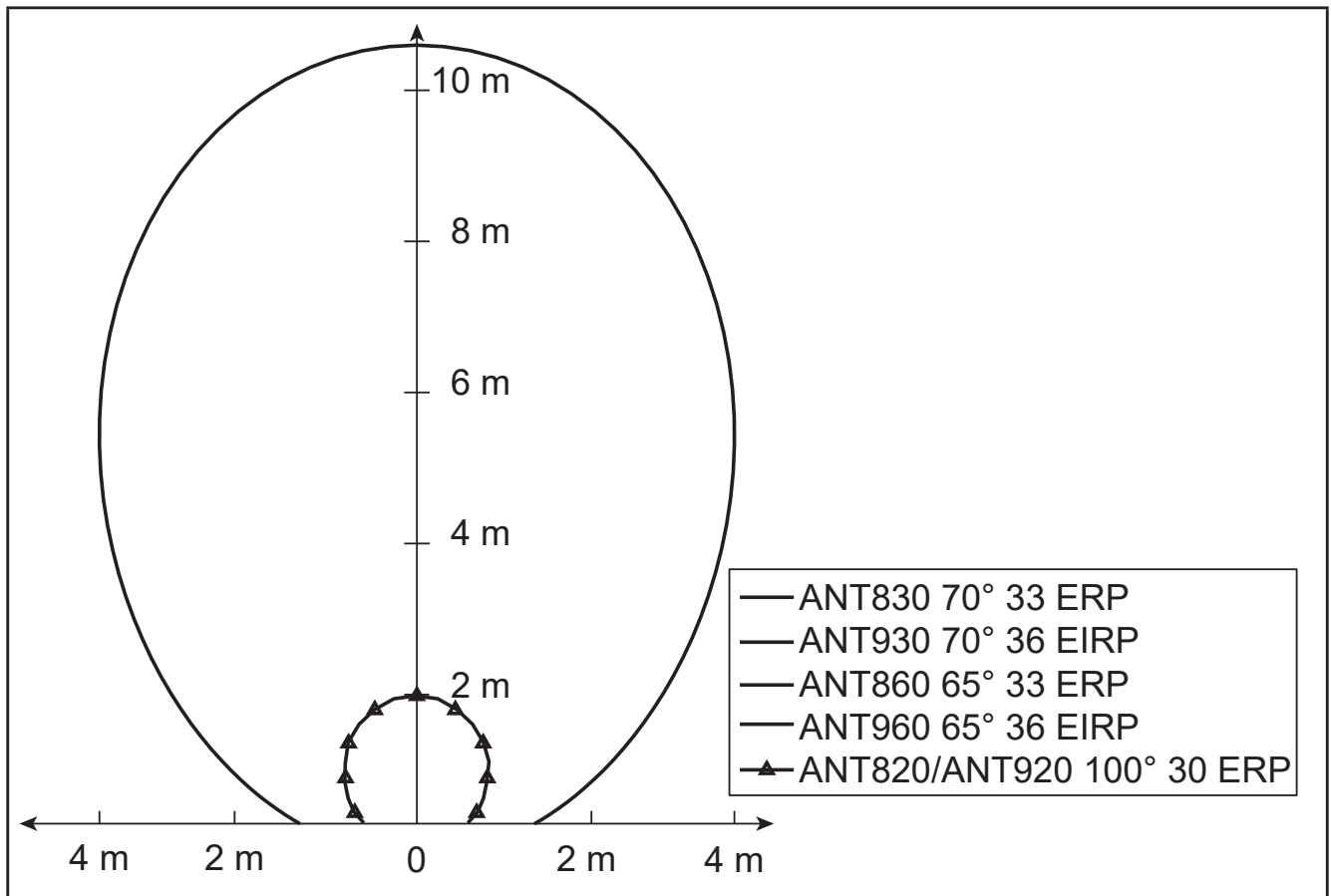

 Operate the ifm UHF RFID antennas only with ifm UHF readers to ensure best read and write results.

4 Reading range and selectivity

The reading range and the selectivity are the most important features of an RFID application. The reading range describes the greatest distance at which a tag can be read. The selectivity indicates the required minimum distance for clear distinction between two adjacent tags.

The system features depend considerably on the tag type used. In general, the UHF RFID tags can be divided into three groups.

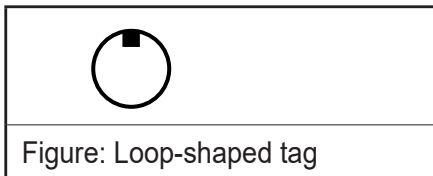

The first group consists of loop-shaped tags that couple magnetically with the antenna. These tags have the smallest ranges since the magnetic field decreases rapidly with the distance from the antenna.

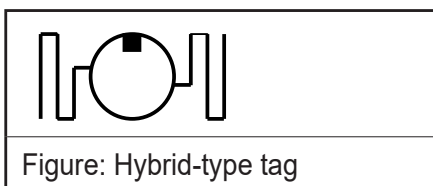

The second group consists of hybrid-type tags which are a mix of loop-shaped and dipole-type tags. These tags can be activated by the antenna via the magnetic field, the electric field or a combination of both.

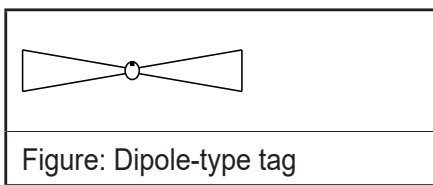

The third group is made up of dipole-type tags (far field tags) which mostly couple via the electric field. Ranges of more than 10 m are possible.

4.1 Antenna allocation according to tag types

The ANT805 ultra-low-range antenna was developed to meet the most challenging demands with regard to range and selectivity of the tags from all three groups. It is a universal antenna for many low-range applications. With this antenna very low reading ranges below 10 cm and high selectivity with far-field tags are possible. It can also read near-field tags at distances of up to 3 cm.

In order to significantly increase the read distance for near-field tags, the ANT810/ANT910 low-range antenna was developed for reading ranges of 7 cm with conventional loop-shaped tags.

The ANT805 ultra-low-range antenna is suited for all groups while the ANT810/ANT910 low-range antenna is particularly suited for use with loop-shaped tags.

4.2 Reading range

In order to quantify the reading range of the ANT805 and ANT810/ANT910 antennas the figures below show the respective reading ranges for different tag designs. The tags are aligned parallel to the antenna.

The ANT805 antenna has a very well-defined reading range for all tags. The ANT810/ANT910 antennas are special solutions for near-field tags with a considerably larger reading range than the ANT805 antenna.

4.3 Selectivity

The high selectivity of the low-range antennas opens up a number of new UHF RFID applications that could not be implemented previously. Both versions can individually read tags with distances of partly less than 5 cm. They are therefore the ideal antennas for item level tagging applications.

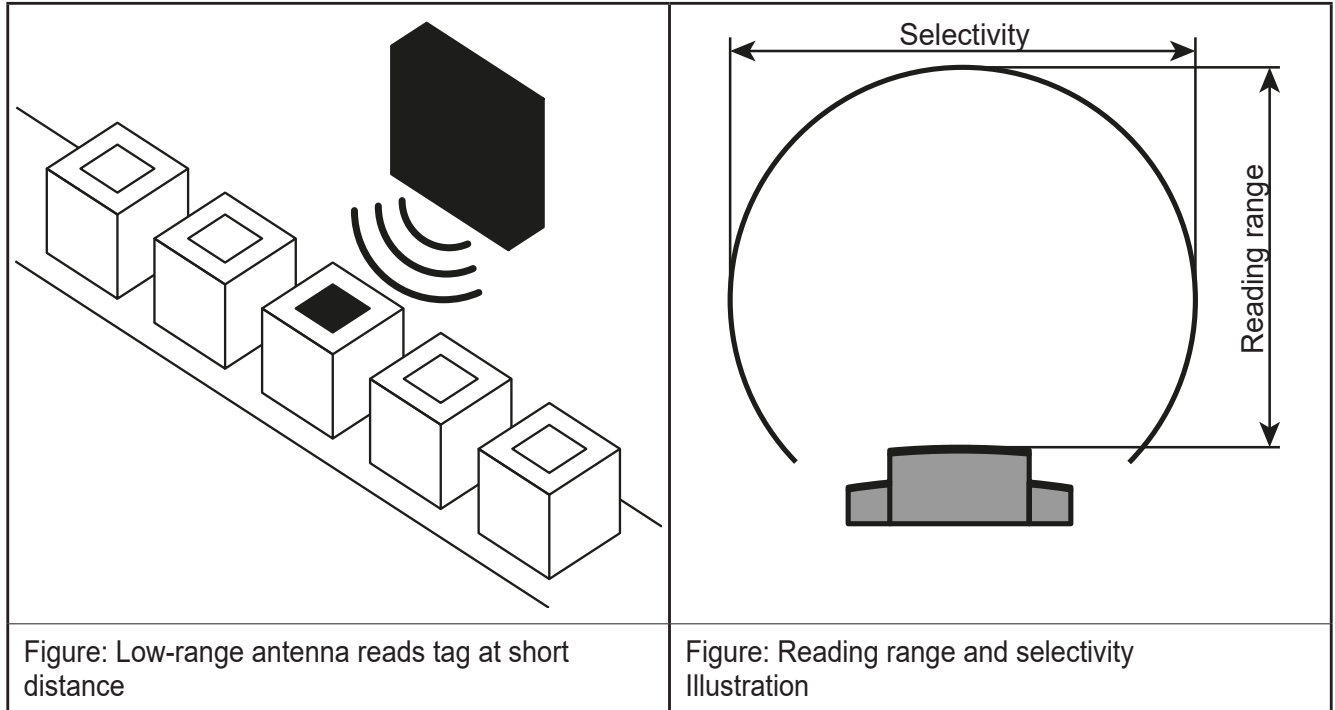

Figure: Low-range antenna reads tag at short distance

Figure: Reading range and selectivity Illustration

4.4 Selectivity and reading range of the low-range antennas

The table below lists the selectivity and reading ranges of the ultra-low-range and low-range antennas.

Tag type	ANT805 ultra-low range		ANT810/ANT910 low range	
	Selectivity	Reading range	Selectivity	Reading range
Loop-shaped 	3 cm	2 cm	4 cm	4 cm
Hybrid-type 	7 cm	5 cm	-	-
Dipole-type 	10 cm	8 cm	-	-

Figure: Selectivity and reading range of ANT805 / ANT810 / ANT910

5 Conformity with standards

Since the RFID systems are radio systems, they are in the scope of the 1999/5/EC guideline of the European Commission (Radio and Telecommunications Terminal Equipment R&TTE).

As evidence of the conformity with the basic requirements of this guideline there is a number of harmonised standards that are published in the Official Journal of the European Union.

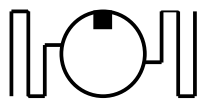
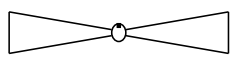
The ifm antennas have a passive antenna structure. The system integrator is responsible for meeting the standards - that means the person who combines the individual components of an RFID system, in particular the readers and the antennas. Therefore it is expressly recommended to acquire these standards.

Two important standards in connection with antennas are (not exhaustive) EN 302208 and EN 50364: The first one deals with radio spectrum matters and limits the maximally radiated power while EN 50364 deals with the limitation of human exposure to electromagnetic fields.

As evidence of the antenna conformity with the standard EN 50364 the specific absorption rate (SAR) is calculated numerically. The determined SAR values are compared with the basic limit values of EN 50364 - classified to occupational exposure, exposure of the general public and local exposure of head and trunk and limbs. The WiRa is in general used for applications with a reading area starting with 20 cm. At this distance the values are significantly below the maximum SAR values permitted by law. In case that use is intended for smaller distances, the respective SAR values are numerically calculated. The assumptions taken as basis (such as operating mode of the RFID system and characteristics of the human tissue) ensure a conservative estimate of the exposure (worst case scenario).

The calculation was also made for the most sensitive constellation i.e. for the case that members of the general public stay permanently in direct vicinity of the antenna with their head or trunk. If the distance between the person and the antenna is less than 3 cm, the ANT820 ensures that the maximally allowed SAR is not reached with an antenna input power of up to 0.34 W (25.31 dBm). In all other cases the ANT820 can be operated with the maximally radiated power of 0.5 W ERP (27 dBm) or an antenna input power of 0.653 W (28.15 dBm). The table below shows the maximum input powers with which the antenna may be supplied to ensure that the basic limit values of the SAR are not exceeded. Two different types of exposure are differentiated:

Max. input power ANT805 / ANT810 / ANT815 / ANT910	Direct contact with ANT805 / ANT815	Direct contact with ANT810 / ANT910
Occupational exposure Limit values head and trunk 10 W/kg Limit values local limbs 20 W/kg	Pin = 1 W (30 dBm)	Pin = 0.5 W (27 dBm)
General public Local limbs exposure Limit values local limbs 4 W/kg	Pin = 1 W (30 dBm)	Pin = 0.5 W (27 dBm)
General public Head and trunk exposure Limit values head and trunk 2 W/kg	Pin = 1 W (30 dBm)	Pin = 0.1 W (20 dBm)

Max. input power ANT920 / ANT820	Distance person and ANT920 / ANT820 < 1 cm	1 cm < distance person and ANT920 / ANT820 < 7 cm	7 cm < distance person and ANT920 / ANT820
General public Limit values head and trunk 2 W/kg Limit values local limbs 4 W/kg	Pin = 0.32 W		Pin = 1.84 W
Occupational exposure Limit values head and trunk 10 W/kg	Pin = 1.75 W	Pin = 1.84 W	
Occupational exposure Limit values local limbs 20 W/kg	Pin = 1.84 W		

Max. input power ANT830 / ANT930 / ANT860 / ANT960	Distance person and ANT830 / ANT930 < 5 cm	Distance person and ANT830 / ANT930 ≥ 5 cm
General public Limit values head and trunk 2 W/kg Limit values local limbs 4 W/kg	$P_{on} = 697 \text{ mW}$ (28.41 dBm)	$P_{on} = 923 \text{ mW}$ (29.65 dBm)
Occupational exposure Limit values head and trunk 10 W/kg Limit values local limbs 20 W/kg	$P_{on} = 923 \text{ mW}$ (29.65 dBm)	

6 Installation

6.1 Installation location

To reach the maximum range of the antennas there must not be any interfering objects between the antenna and the tag to be read. The operating principle of the antenna is influenced by the type of fixing and the surrounding materials. To ensure optimum antenna performance there should be no conductive objects in the vicinity of the antenna. The following figures are given as sufficient distances:

The distance to large metal surfaces and the ground should be min. 70 cm (see Figure 1).

If the installation in front of a metal surface cannot be avoided, a mounting fixture can be used establishing a distance of exactly 12 cm between the rear of the antenna and the metal surface (see Figure 2).

With direct installation on a metal surface (e.g. a plate as part of a mounting fixture) use a square-shaped metal plate which should not exceed the dimensions 16 x 16 cm (see Figure 3).

In addition other objects such as tanks filled with liquids located in direct vicinity affect the functions of the antenna.

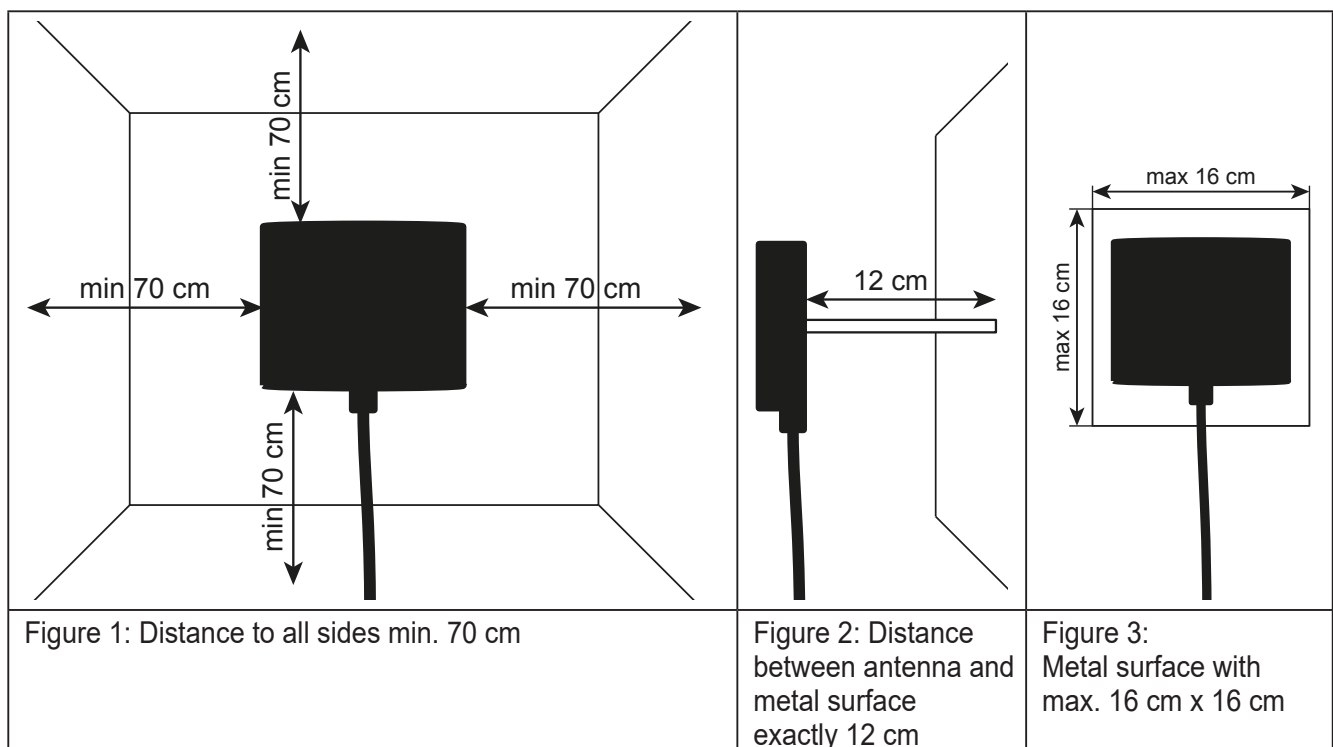

If the recommended distances are not observed, the antenna characteristics change. The antenna needs to be re-evaluated in the respective installation. The interference can be determined and minimised via the transmission level, for example.

6.2 Laying of cables

Observe the following notes when laying the cables:

- Lay the cables vertically and straight away from the antenna (see figure on the right).
- Avoid cable loops around and on the antenna (see figure on the left).

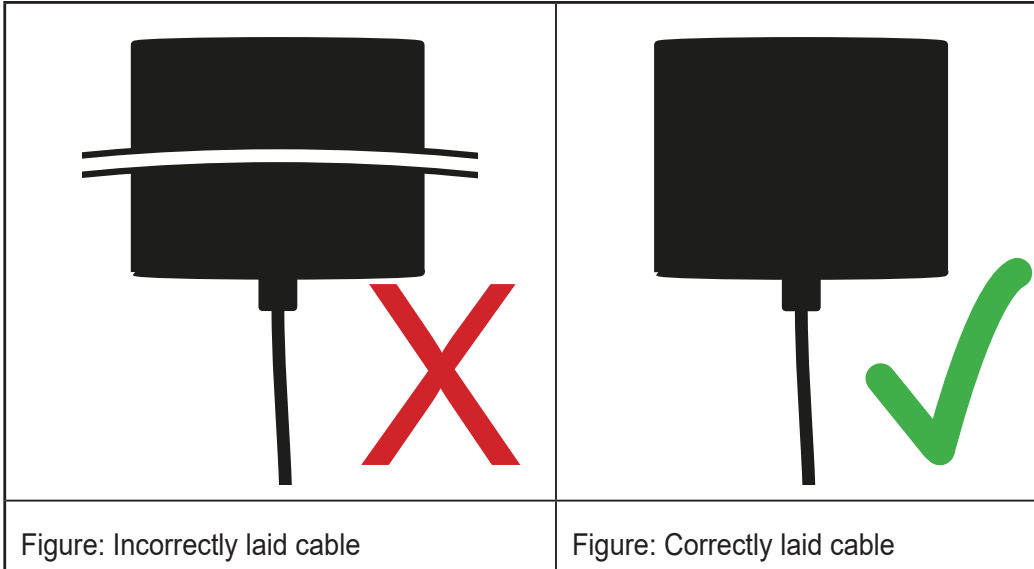

7 Typical applications

7.1 Pharmaceutical industry

The reading ranges of the ANT810 / ANT910 low-range antennas ensure the selection of individual pharmaceutical articles so that each drug can be traced right from the production. Since the low-range antennas couple primarily via the magnetic field, the tags can be directly positioned on bottles and blister packs.

To obtain the optimum performance it is recommended to use the ANT810/ ANT910 antennas together with loop-shaped tags.

7.2 Access systems

Due to the large reading area of UHF antennas applications for access systems had been implemented via HF RFID so far. The new UHF RFID low-range antennas from ifm now allow these applications as well.

The use of loop-shaped tags in conjunction with the ANT805 ultra-low range antenna is recommended. The tags are only read by the ifm low-range antennas in a defined range. This ensures that errors during reading and undesired monitoring of people is excluded.

The ANT820 / ANT920 mid-range antennas are recommended for access systems such as ski lifts, buses and trains. That means that tickets can now be checked at medium distance.

7.3 Automation industry

The low-range antennas can be used for RFID automation applications with a defined reading area and high selectivity. Of great advantage is the possibility to detect far-field tags with the ANT805 antenna individually and to read the same tags with mid-range or wide-range antenna at other reading stations at larger distances in multi-tag operation.

7.4 Other applications for mid-range antennas

Other typical applications for the ANT820 / ANT920 mid-range antennas:

- Logistics applications when installed on autonomous industrial transport systems
- Conveyor technology applications
- Gate applications for detecting goods
- Bulk and single tag applications



For use of the antennas note the effective national regulations and the standards and guidelines possibly valid in particular for the application or its location.

8 Abbreviations

The following abbreviations are used in these instructions:

Abbreviation	Meaning
DIN	German Institute for Standardisation
EN	European standard
ERP	Effective Radiated Power
RFID	Radio Frequency Identification
SAR	Specific Absorption Rate
UHF	Ultra High Frequency
ETSI	European Telecommunications Standards Institute
FCC	Federal Communications Commission

9 Approvals

The table below lists the approvals of the respective antenna.

Antenna	FCC (902 - 928 MHz)	ETSI (865 - 868 MHz)
ANT805	X	X
ANT810		X
ANT815	X	X
ANT820		X
ANT830		X
ANT910	X	
ANT920	X	
ANT930	X	
ANT860		X
ANT960	X	

10 Maintenance, repair and disposal

The device does not contain any components that need to be maintained.

- ▶ Do not open the device.
- ▶ The device must only be repaired by the manufacturer.
- ▶ Dispose of the device in accordance with the national environmental regulations.

UK