

ifm electronic



Operating instructions  
Compressed air meter

**efector300<sup>®</sup>**

**SD2000**

**UK**

11406629 / 00 10 / 2013

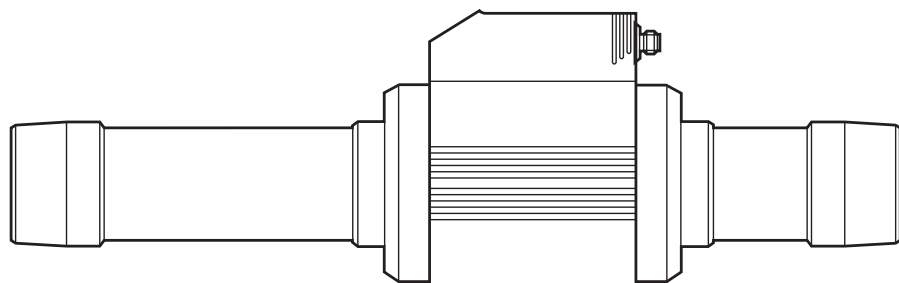

# Contents

1	Preliminary note.....	4
1.1	Symbols used .....	4
2	Safety instructions .....	4
3	Functions and features .....	5
4	Function.....	5
4.1	Processing of the measured signals.....	5
4.2	Volumetric flow monitoring.....	6
4.3	Consumed quantity monitoring (totalizer function) .....	6
4.3.1	Consumed quantity monitoring with pulse output.....	6
4.3.2	Consumed quantity monitoring with preset counter .....	6
4.4	Temperature monitoring.....	7
4.5	Volumetric flow or temperature monitoring / switching function.....	7
4.6	Volumetric flow or temperature monitoring / analogue function.....	8
4.7	Setting of the standard conditions of the volume flow .....	8
4.8	Low flow cut-off (LFC).....	9
5	Installation.....	9
5.1	Installation location .....	9
5.2	Installation conditions .....	9
5.3	Installation position .....	10
5.4	Installation in pipes .....	10
6	Electrical connection.....	11
7	Operating and display elements .....	12
8	Menu.....	13
8.1	Menu structure.....	13
8.2	Explanation of the menu.....	14
9	Parameter setting .....	15
9.1	General parameter setting.....	15
9.2	Settings for volumetric flow monitoring.....	17
9.2.1	Settings for limit value monitoring with OUT1.....	17
9.2.2	Settings for limit value monitoring with OUT2.....	17
9.2.3	Setting the analogue value for volumetric flow .....	17
9.3	Settings for consumed quantity monitoring .....	18

9.3.1	Settings for quantity monitoring via pulse output.....	18
9.3.2	Settings for quantity monitoring via the preset counter .....	18
9.3.3	Settings for program-controlled counter reset .....	18
9.3.4	Deactivation of the counter reset.....	18
9.3.5	Counter reset using an external signal .....	18
9.4	Settings for temperature monitoring .....	19
9.4.1	Settings for limit value monitoring with OUT2.....	19
9.4.2	Setting the analogue value for temperature .....	19
9.5	User settings (optional).....	19
9.5.1	Setting of the standard unit of measurement for volumetric flow.....	19
9.5.2	Configuration of the standard display .....	19
9.5.3	Setting of measured value damping .....	20
9.5.4	Setting of the error behaviour of the outputs .....	20
9.5.5	Setting of the standard pressure to which the measured and display values for volumetric flow refer.....	20
9.5.6	Setting of the standard temperature to which the measured and display values for volumetric flow refer .....	20
9.5.7	Setting of the low flow cut-off.....	20
9.6	Service functions .....	21
9.6.1	Reading of the min/max values for the volumetric flow .....	21
9.6.2	Reset of all parameters to factory setting .....	21
9.7	Setting of the preset counter / the pulse value (ImPS) .....	21
10	Operation .....	23
10.1	Reading of set parameters .....	24
10.2	Changing the display unit in the Run mode .....	24
10.3	Error indications.....	24
10.4	General operating conditions .....	24
11	Technical data and scale drawing .....	24
12	Factory setting .....	25

# 1 Preliminary note

## 1.1 Symbols used

► Instruction

> Reaction, result

[...] Designation of pushbuttons, buttons or indications

→ Cross-reference



Important note

Non-compliance can result in malfunction or interference.



Information

Supplementary note.

## 2 Safety instructions

- Please read this document prior to set-up of the unit. Ensure that the product is suitable for your application without any restrictions.
- Work on compressed air systems as well as mounting, setting for operation and set-up of the unit must be carried out by qualified personnel. When doing so, state of the art as well as safety and accident prevention regulations have to be adhered to.
- Ensure before mounting the components into or removing them from the compressed air system that the installation is at a standstill and no pressure is applied.
- Improper or non-intended use may lead to malfunctions of the unit or to unwanted effects in your application. That is why installation, electrical connection, set-up, operation and maintenance of the unit must only be carried out by qualified personnel authorised by the machine operator.
- Check the compatibility of the product materials (→ 11 Technical data and scale drawing) with the media to be measured in all applications.
- In order to guarantee the correct condition of the device for the operating time it is necessary to use the device only for media to which the wetted materials are sufficiently resistant (→ Technical data).
- The responsibility whether the measurement devices are suitable for the respective application lies with the operator. The manufacturer assumes no

liability for consequences of misuse by the operator. Improper installation and use of the measurement devices results in a loss of the warranty claims.

### 3 Functions and features

The unit monitors the standard volume flow of compressed air in industrial use. It detects the 4 process categories flow velocity, volumetric flow quantity, consumed quantity, medium temperature.

- Applications: compressed air systems in industrial use.
- All indications apply for standard volume flow to DIN ISO 2533, i.e. volume flow at 1013 hPa, 15 °C and 0 % relative air humidity.
- The unit can be set to different standard conditions (→ 9.5.5 and 9.5.6).
- The general operating conditions of compressed air equipment apply.
- Pressure Equipment Directive (PED): Devices with a measuring section comply with art. 3 sec. (3) of the Directive 97/23/EC and are designed and manufactured for stable gases of the fluid group 2 in accordance with sound engineering practice.

UK

### 4 Function

#### 4.1 Processing of the measured signals

- The unit displays the current process values.
- It generates 2 output signals according to the parameter setting.

OUT1: 4 selection options

- Switching signal for volumetric flow limit value ..... (→ 9.2.1)
- or switching signal for flow velocity limit value ..... (→ 9.2.1)
- or pulse sequence for quantity meter ..... (→ 9.3.1)
- or switching signal for preset counter ..... (→ 9.3.2)

OUT2: 6 selection options

- Switching signal for volumetric flow limit value ..... (→ 9.2.2)
- or switching signal for flow velocity limit value ..... (→ 9.2.2)
- or switching signal for temperature limit value ..... (→ 9.4.1)
- or analogue signal for volumetric flow quantity ..... (→ 9.2.3)
- or analogue signal for flow velocity ..... (→ 9.2.3)
- or analogue signal for temperature ..... (→ 9.4.2)

Instead of an output OUT2 (Pin2) can be used as an input

- for an external reset signal: ..... (→ 9.3.5)

## 4.2 Volumetric flow monitoring

The flow is monitored by a calorimetric measuring system, the measured signals are evaluated by the electronics.

- 2 switching signals for volumetric flow limit values can be provided (output 1 and output 2). Switching functions → 4.5.
- An analogue signal which is proportional to the volumetric flow (4...20 mA) can be provided on output 2. Analogue functions → 4.6.

## 4.3 Consumed quantity monitoring (totalizer function)

The unit has an internal quantity meter which continuously totals the volumetric flow quantity. The sum corresponds to the current consumed quantity since the last reset.

- The current meter reading can be displayed.
- In addition the value before the last reset is stored. This value can also be displayed.

The meter saves the totalled consumed quantity every 10 minutes. After a power failure this value is available as the current meter reading. If a time-controlled reset is set, the elapsed time of the set reset interval is also stored. So the possible data loss can be maximum 10 minutes.

- Overflow: After the maximum value (9,999,999 Nm<sup>3</sup>) the meter is reset to 0.

The meter can be reset as follows:

- Manual reset (→ 9.3.3.).
- Time-controlled automatic reset (→ 9.3.3.).
- External input signal on pin 2 (→ 9.3.5).

### 4.3.1 Consumed quantity monitoring with pulse output

Output 1 provides a counting pulse each time the value set in [ImPS] is reached (→ 9.3.1).

### 4.3.2 Consumed quantity monitoring with preset counter

2 types of monitoring are possible:

- Time-dependent quantity monitoring.
  - Settings: [ImPS] = quantity X, [ImPR] = [no], [rTo] = time t.
  - If the quantity x is reached during the time t, output 1 switches and remains switched until the meter is reset via the digital input or [rTo] = [rED.T].



In this case the time-controlled totalizer reset is not carried out if [ImPS] = quantity X exceeded.

- If the quantity  $x$  is not reached during the time  $t$ , the meter is automatically reset and counting starts again; output 1 does not switch.
- Quantity monitoring not time-dependent.
  - Settings:  $[ImPS] = \text{quantity } x$ ,  $[ImPR] = [no]$ ,  $[rTo] = [OFF]$ .
  - If the quantity  $x$  is reached during the time  $t$ , output 1 switches and remains switched until the meter is reset via the digital input or  $[rTo] = [rED.T]$ .

#### 4.4 Temperature monitoring

- A switching signal for temperature limit values can be provided on output 2. Switching functions  $\rightarrow$  4.5.
- An analogue signal which is proportional to the temperature (4...20 mA) can be provided on output 2. Analogue functions  $\rightarrow$  4.6.

UK

#### 4.5 Volumetric flow or temperature monitoring / switching function

OUT $x$  changes its switching state if it is above or below the set switching limits (SP $x$ , rP $x$ ). The following switching functions can be selected:

- Hysteresis function / normally open (figure 1):  $[OUx] = [Hno]$ .
  - Hysteresis function / normally closed (figure 1):  $[OUx] = [Hnc]$ .
- First the set point (SP $x$ ) is set, then the reset point (rP $x$ ) with the requested difference. Note: when SP $x$  is adjusted rP $x$  is changed automatically; the difference remains constant.
- Window function / normally open (fig. 2):  $[OUx] = [Fno]$ .
  - Window function / normally closed (figure 2):  $[OUx] = [Fnc]$ .
- The width of the window can be set by means of the difference between SP $x$  and rP $x$ . SP $x$  = upper value, rP $x$  = lower value.

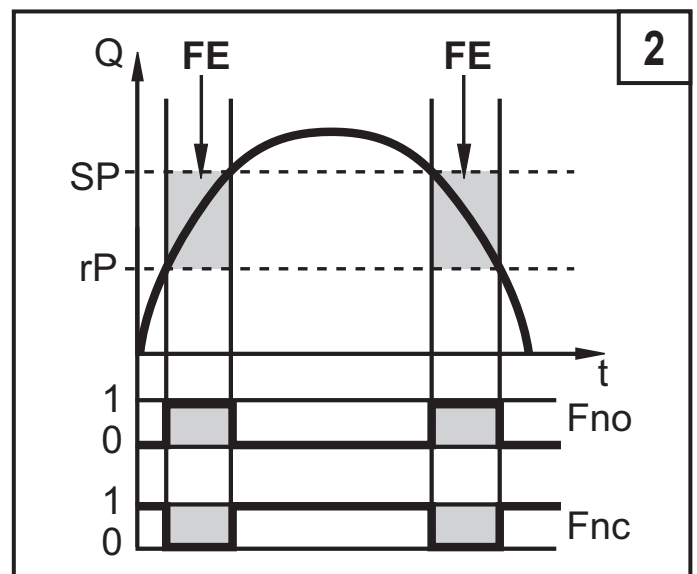
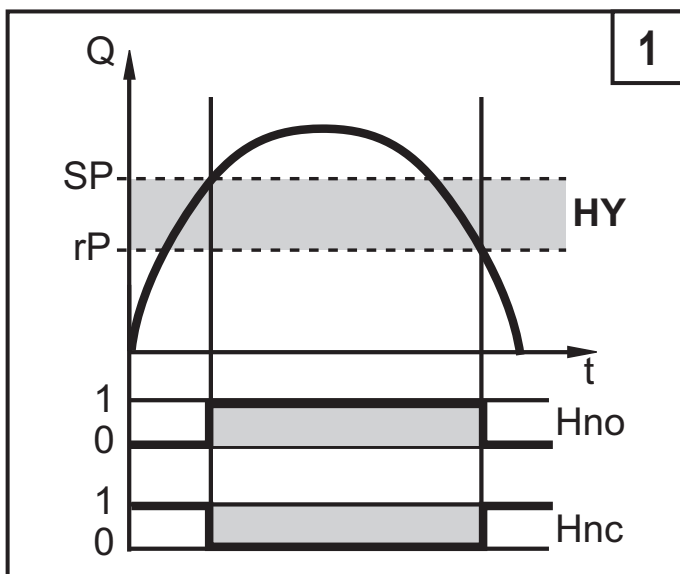

HY = hysteresis; FE = window

## 4.6 Volumetric flow or temperature monitoring / analogue function

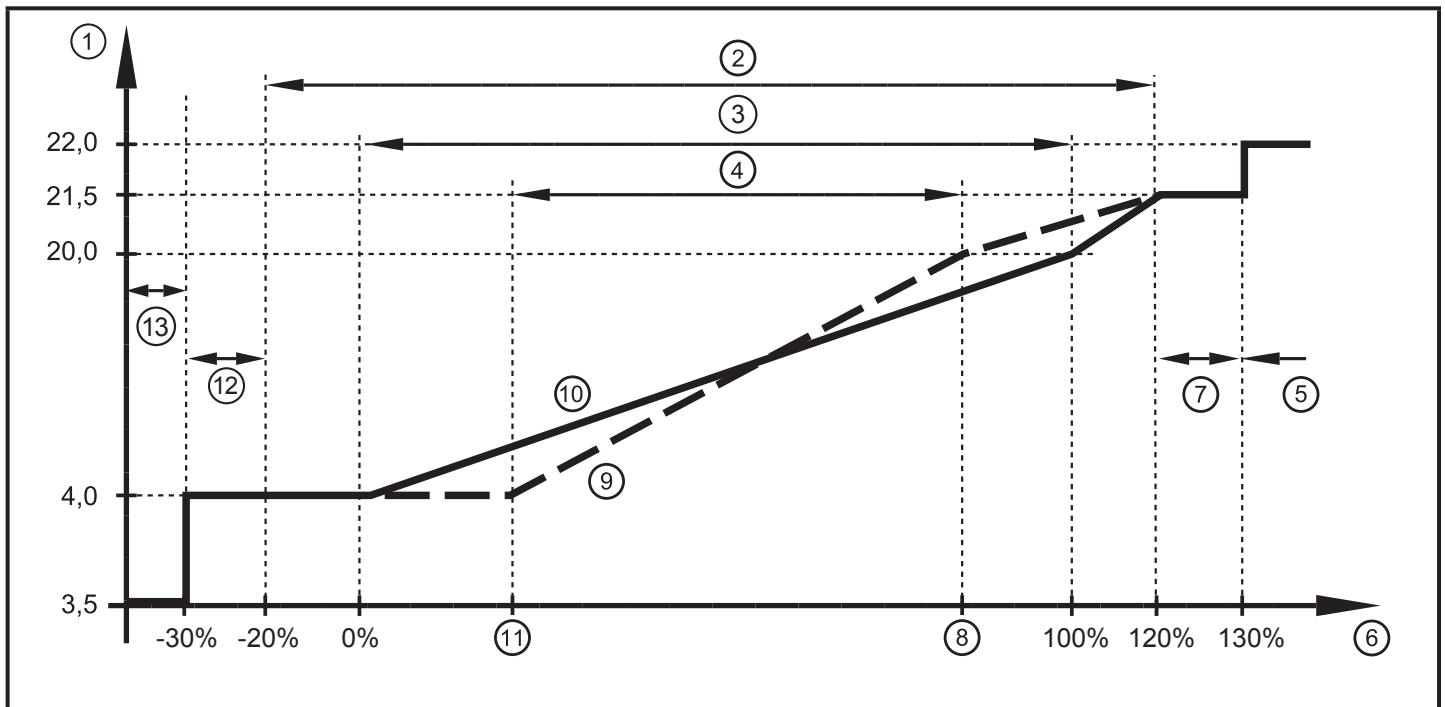

Characteristics of the analogue output to the standard IEC 60947-5-7

1: Output current in mA

2: Operating area

3: Measuring range

4: Range between analogue start point and analogue end point

5: Error message [Err] is displayed

6: Final value of the measuring range (VMR)

7: Error message [OL] is displayed (= overload)

8: Analogue end point (AEP): determines at which measured value the output signal is 20 mA.

9: Curve of the analogue signal with shifted analogue start point

10: Curve of the analogue signal at factory setting

11: Analogue start point (ASP): determines at which measured value the output signal is 4 mA.

12: Error message [UL] is displayed (= underload)

13: Error message [Err] is displayed



Minimum distance between ASP and AEP = 25 % of the final value of the measuring range.

## 4.7 Setting of the standard conditions of the volume flow

The unit is adjusted to a standard volume flow to DIN ISO 2533, i.e. volume flow at 1013 hPa, 15 °C and 0 % relative air humidity.

The unit can be set to different standard conditions:



- Via the menu item [rEF.P] the standard pressure is set, which serves as a reference for the measured and display values for volumetric flow (→ 9.5.5).
- Via the menu item [rEF.T] the standard temperature is set, which serves as a reference for the measured and display values for volumetric flow (→ 9.5.6).

## 4.8 Low flow cut-off (LFC)

With this function small volumetric flow quantities can be suppressed (→ 9.5.7). Flows below the LFC value have no effect on the display and output signals. Example: For LFC = 0.5 volumetric flow quantities below 0.5 Nm<sup>3</sup>/h are suppressed.

UK

## 5 Installation

 The rules and regulations for the installation and operation of compressed air equipment must be observed.

### 5.1 Installation location



- Behind the cold dryer / near the load.
- If compressed air is fed into the main pipe through parallel pipes, the unit should be mounted in the main pipe.
- Installation after the maintenance unit is also possible (if oil is used for the loads, the units must be mounted before the oiler).



### 5.2 Installation conditions

To achieve the specified measurement accuracy, the following installation conditions must be adhered to: defined inlet and outlet pipe lengths, defined flow cross-section area, fixed installation depth and correct positioning of the measuring elements.

The unit is mounted in a measuring range which meets these conditions.

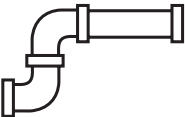
In case of disturbances on the inflow side additional calming sections (B) are recommended:

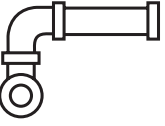
	changes to the pipe diameter	$B = 5 \times \text{pipe diameter}$
	90° elbow	$B = 5 \times \text{pipe diameter}$
	two 90° elbows, one plane	$B = 10 \times \text{pipe diameter}$

	two 90° elbows, two planes	$B = 15 \times \text{pipe diameter}$
	valve, slide	$B = 35 \times \text{pipe diameter}$

### 5.3 Installation position

- Permitted installation positions: pipe length vertical, any position (fig. 1, 2); pipe length horizontal, unit vertical (fig. 3, 5), unit on side, pipe length left (fig. 4).
- Avoid the installation position in fig. 6 (unit on side, pipe length right). If the flow rate is low, the specified measurement accuracy cannot be adhered to.

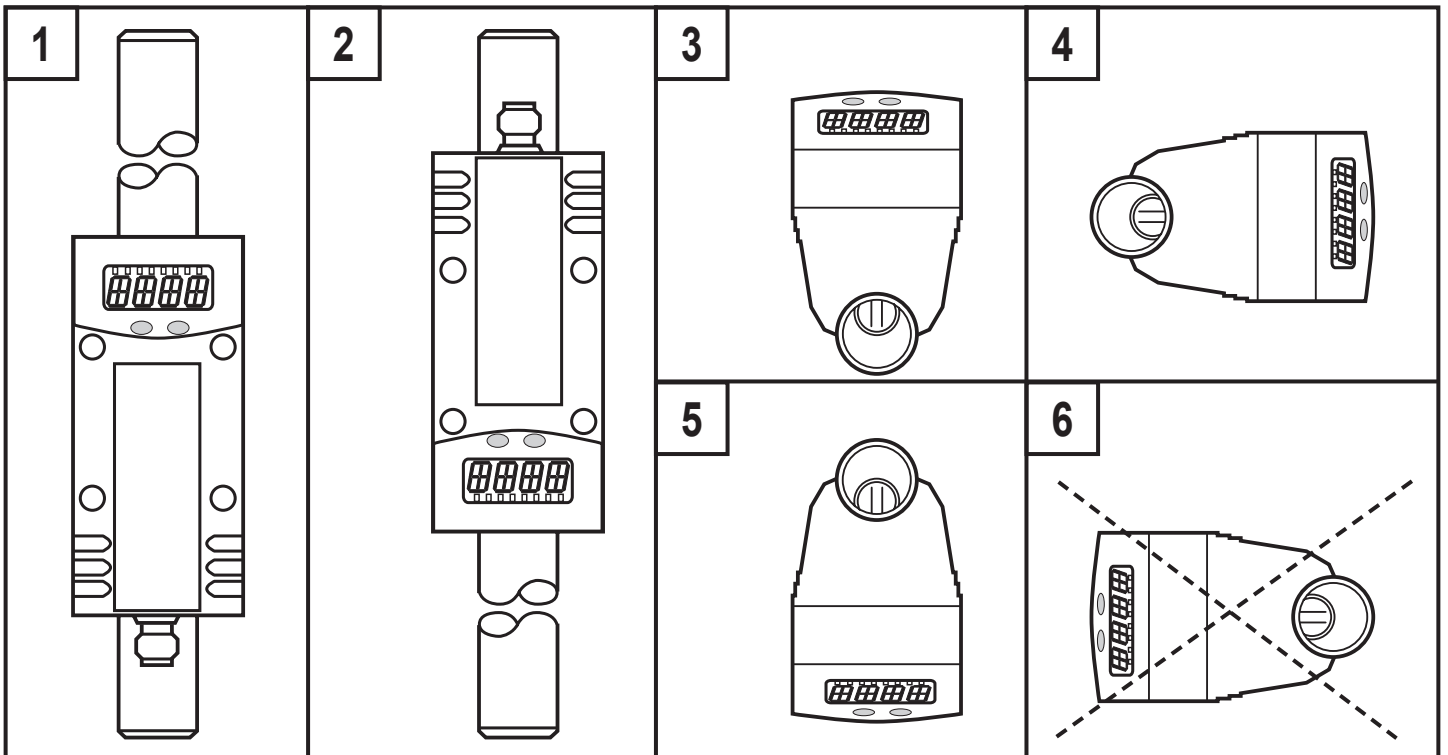

### 5.4 Installation in pipes

- Fit the unit in the pipe in accordance with the flow direction (arrow on the unit) and tighten.

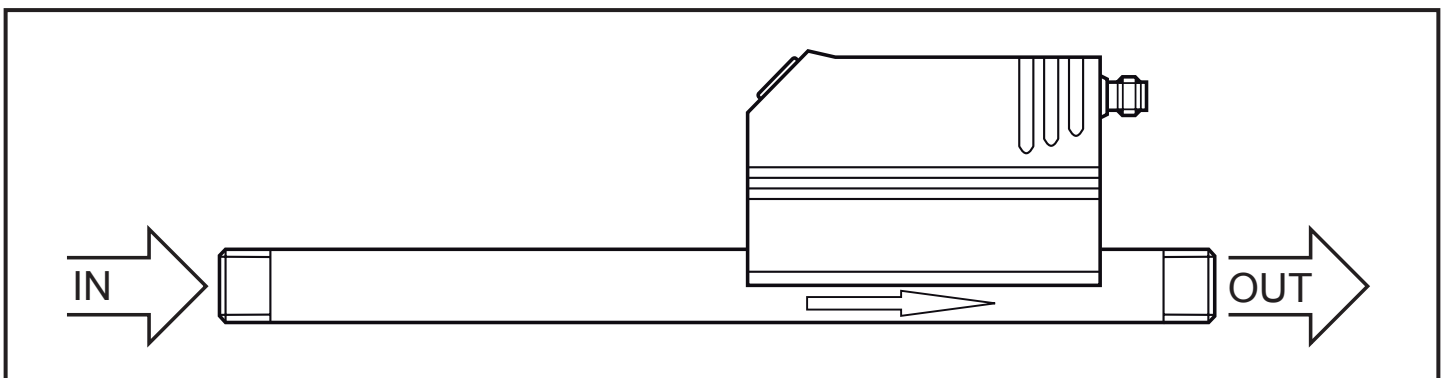

## 6 Electrical connection



The unit must be connected by a qualified electrician.

The national and international regulations for the installation of electrical equipment must be adhered to.

Voltage supply according to EN 50178, SELV, PELV.

- ▶ Disconnect power.
- ▶ Connect the unit as follows:

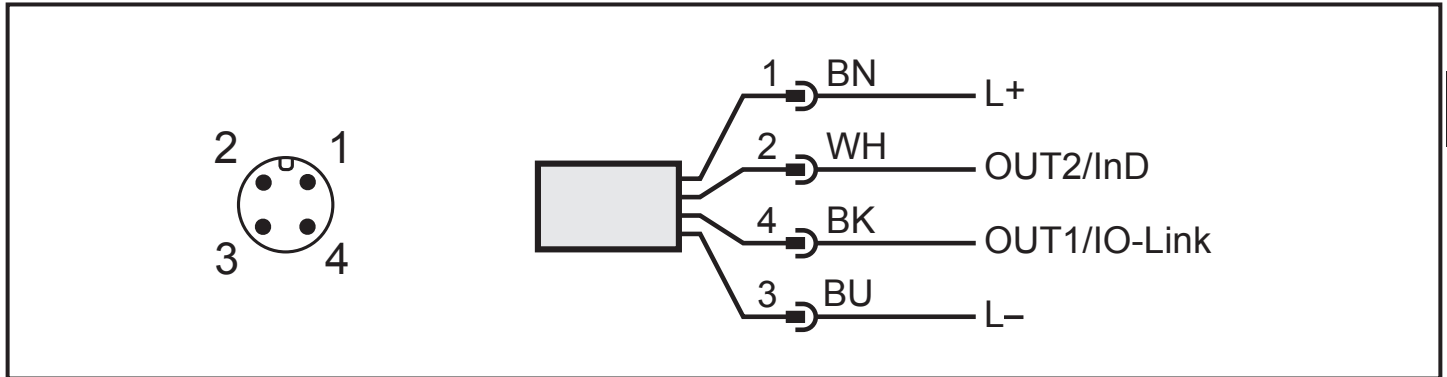

UK

<b>Pin 1</b>	Ub+
<b>Pin 3</b>	Ub-
<b>Pin 4 (OUT1)</b>	Switching signal: limit values for volumetric flow. Switching signal: quantity meter reached preset value. Pulses: 1 pulse every time the defined volumetric flow quantity is reached. Data channel for bidirectional communication. IO-Link.
<b>pin 2 (OUT2/InD)</b>	Switching signal: limit values for volumetric flow. Switching signal: limit values for temperature. Analogue signal for volumetric flow. Analogue signal for temperature. Input for signal "counter reset".

Core colours of ifm sockets:

1 = BN (brown), 2 = WH (white), 3 = BU (blue), 4 = BK (black)

## 7 Operating and display elements

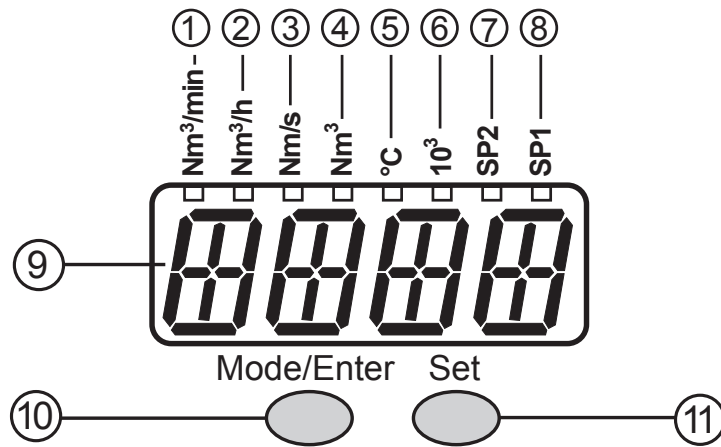

### 1 to 8: Indicator LEDs

- LED 1 (green) = current volumetric flow in standard cubic metres / minute ( $\text{Nm}^3/\text{min}$ ).
- LED 2 (green) = current volumetric flow in standard cubic metres / hour ( $\text{Nm}^3/\text{h}$ ).
- LED 3 (green) = current flow velocity in standard metres / second ( $\text{Nm}/\text{s}$ ).
- LED 4 (green) = current consumed quantity since the last reset in standard cubic metres ( $\text{Nm}^3$ ).
- LED 4 (green) flashing = consumed quantity before the last reset in standard cubic metres ( $\text{Nm}^3$ ).
- LED 4 (green) and 6 (green) = current consumed quantity since the last reset in standard cubic metres (values > 9999 are displayed using the  $10^3$  exponential notation).
- LED 4 (green) and 6 (green) flashing = consumed quantity before the last reset in  $10^3$  standard cubic metres (values > 9999 are displayed using the  $10^3$  exponential notation).
- LED 5 (green) = current medium temperature in  $^{\circ}\text{C}$ .
- LED 7 (yellow) = switching status of the corresponding output (LED indicates the input status also with an active external reset).
- LED 8 (yellow) = switching status of the corresponding output.

### 9: Alphanumeric display, 4 digits

- Indication of the current volumetric flow quantity (if [Uni] = [nm3h] and [SELD] = [FLOW] is set).
- Indication of the current flow velocity (if [Uni] = [nmS] and [SELD] = [FLOW] is set).
- Indication of the meter reading (if [SELD] = [TOTL] is set).
- Indication of the current medium temperature (if [SELD] = [TEMP] is set).
- Indication of the parameters and parameter values.

### 10: Mode/Enter button

- Selection of the parameters and acknowledgement of the parameter values.

### 11: Set button

- Setting of the parameter values (scrolling by holding pressed; incremental by pressing briefly).
- Change of the display unit in the normal operating mode (Run mode).

# 8 Menu

## 8.1 Menu structure

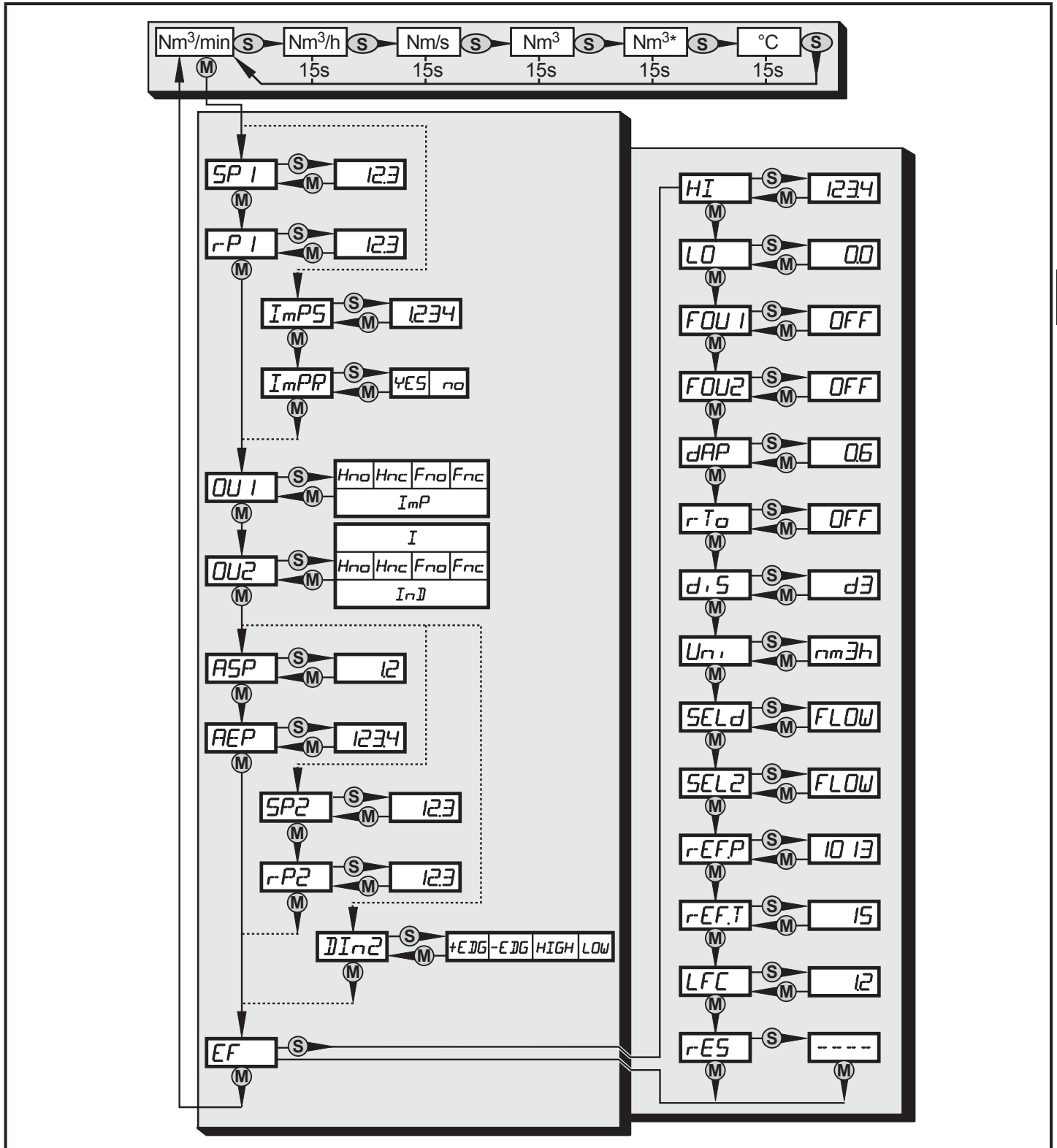

UK

- (M) = [Mode/Enter] / (S) = [Set]
- Nm<sup>3</sup> = current meter reading in Nm<sup>3</sup> / Nm<sup>3\*</sup> = stored meter reading in Nm
- The parameter values displayed in the form of numbers are factory settings or random examples.

## 8.2 Explanation of the menu

SP1/rP1	Upper / lower limit value for volumetric flow.
ImPS	Pulse value.
ImPR	Pulse repetition active (= pulse output) or not active (= preset counter function).
OU1	Output function for OUT1 (volumetric flow or consumed quantity): - Switching signal for the limit values: hysteresis function or window function, either normally open or normally closed. - Pulse or switching signal for quantity meter.
OU2	Output function for OUT2 (volumetric flow or temperature): - Switching signal for the limit values: hysteresis function or window function, either normally open or normally closed. - Analogue signal: 4-20 mA [I].
	As an alternative: configure OUT2 (Pin2) as input for external reset signal: setting: [OU2] = [InD].
SP2/rP2	Upper / lower limit value for volumetric flow or temperature.
ASP / AEP	Analogue start value / analogue end value for volumetric flow or temperature.
DIn2	Configuration of the input (Pin2) for counter reset.
EF	Extended functions / opening of menu level 2.
HI / LO	Maximum / minimum value memory for volumetric flow.
FOU1	Behaviour of output 1 in case of an internal fault.
FOU2	Behaviour of output 2 in case of an internal fault.
dAP	Measured value damping / damping constant in seconds.
rTo	Counter reset: manual reset / time-controlled reset.
diS	Update rate and orientation of the display.
Uni	Standard unit of measurement for volumetric flow: Nm <sup>3</sup> /min, Nm <sup>3</sup> /h or Nm/s.
SELd	Standard measuring unit of the display: volumetric flow value, meter reading or medium temperature.
SEL2	Standard unit of measurement for evaluation by OUT2: - limit value signal or analogue signal for volumetric flow. - limit value signal or analogue signal for temperature.
rEF.P	Standard pressure to which the measured and display values for volumetric flow refer.
rEF.T	Standard temperature to which the measured and display values for volumetric flow refer.
LFC	Low flow cut-off.

## 9 Parameter setting

Parameters can be set before installation and set-up of the unit or during operation.



If you change parameters during operation, the operating principle of the plant will be influenced.

► Ensure that there will be no malfunctions in your plant.

Using an IO-Link capable parameter setting tool such as the FDT service program ifm Container the following options are available:

- Reading current process values.
- Reading, changing and saving current parameter settings and transmitting them to other units of the same type.



The catalogue of the available DTM objects, the IO-Link Device Description (IODD) and the FDT service program ifm Container can be downloaded at [www.ifm.com](http://www.ifm.com) → Service → Download.

### 9.1 General parameter setting

3 steps must be taken for each parameter setting:

<b>1</b>	<b>Parameter selection</b> ► Press [Mode/Enter] until the requested parameter is displayed.	
<b>2</b>	<b>Setting of the parameter value</b> ► Press [Set] and keep it pressed. > Current setting value of the parameter flashes for 5 s. > After 5 s: setting value is changed: incrementally by pressing the button once or continuously by keeping the button pressed.	
Numerical values are incremented continuously. For reducing the value: let the display move to the maximum setting value. Then the cycle starts again at the minimum setting value.		

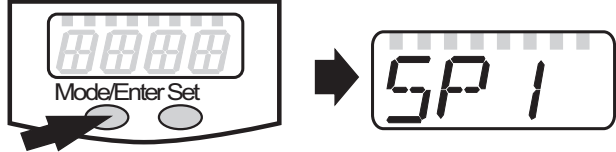
<b>3</b>	<b>Acknowledgement of the parameter value</b> ▶ Press [Mode/Enter] briefly. > The parameter is displayed again. The new setting value is stored.	
----------	---	--

**Setting of other parameters**  
 ▶ Start again with step 1.

**Finishing the parameter setting**  
 ▶ Press [Mode/Enter] several times until the current measured value is displayed or wait for 15 s (from menu level 1) or 30 s (from menu level 2).  
 > The unit returns to the operating mode.

- If [S.Loc] is displayed when an attempt is made to modify a parameter value, either an IO-Link communication is active (temporary locking) or the sensor is permanently locked via software. This locking can only be removed via a parameter setting software.
- Change from menu level 1 to menu level 2:

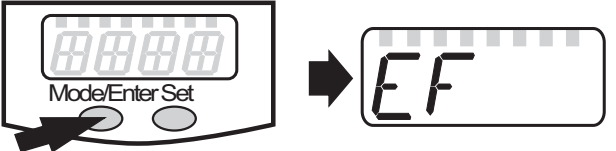
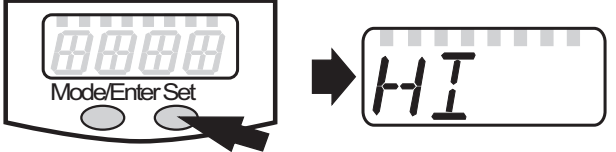
▶ Press [Mode/Enter] until [EF] is displayed.	
▶ Press [Set] briefly. > The first parameter of the submenu is displayed (here: [HI]).	

- Locking/unlocking:  
 The unit can be locked electronically to prevent unintentional settings.

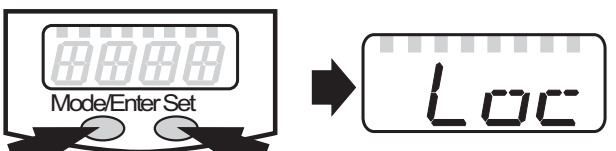
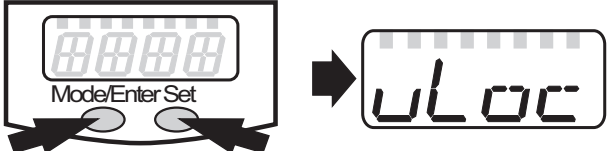
▶ Make sure that the unit is in the normal operating mode. ▶ Press [Mode/Enter] + [Set] for 10 s. > [Loc] is displayed.	
During operation: [LOC] is briefly displayed if you try to change parameter values.	
For unlocking: ▶ Press [Mode/Enter] + [Set] for 10 s. > [uLoc] is displayed.	

When delivered: unlocked



- Timeout:

If no button is pressed for 15 s during parameter setting, the unit returns to the operating mode with unchanged values.

## 9.2 Settings for volumetric flow monitoring

### 9.2.1 Settings for limit value monitoring with OUT1

<ul style="list-style-type: none"> <li>▶ Select [Uni] and set the unit of measurement (→ 9.5.1).</li> <li>▶ Select [OU1] and set the switching function.             <ul style="list-style-type: none"> <li>- [Hno] = hysteresis function/NO</li> <li>- [Hnc] = hysteresis function/NC</li> <li>- [Fno] = window function/NO</li> <li>- [Fnc] = window function/NC</li> </ul> </li> <li>▶ Select [SP1] and set the value at which the output switches.</li> <li>▶ Select [rP1] and set the value at which the output switches off.</li> </ul>	<pre>Uni OU 1 SP 1 r-P 1</pre>
---	--------------------------------

UK

### 9.2.2 Settings for limit value monitoring with OUT2

<ul style="list-style-type: none"> <li>▶ Select [Uni] and set the unit of measurement (→ 9.5.1).</li> <li>▶ Select [SEL2] and set [FLOW].</li> <li>▶ Select [OU2] and set the switching function.             <ul style="list-style-type: none"> <li>- [Hno] = hysteresis function/NO</li> <li>- [Hnc] = hysteresis function/NC</li> <li>- [Fno] = window function/NO</li> <li>- [Fnc] = window function/NC</li> </ul> </li> <li>▶ Select [SP2] and set the value at which the output switches.</li> <li>▶ Select [rP2] and set the value at which the output switches back.</li> </ul>	<pre>Uni SEL2 OU2 SP2 r-P2</pre>
---	----------------------------------

### 9.2.3 Setting the analogue value for volumetric flow

<ul style="list-style-type: none"> <li>▶ Select [Uni] and set the unit of measurement (→ 9.5.1).</li> <li>▶ Select [SEL2] and set [FLOW].</li> <li>▶ Select [OU2] and set the function.             <ul style="list-style-type: none"> <li>- [I] = current signal proportional to volumetric flow (4...20 mA)</li> </ul> </li> <li>▶ Select [ASP] and set the value at which the minimum value is provided.</li> <li>▶ Select [AEP] and set the value at which the maximum value is provided.</li> </ul>	<pre>Uni SEL2 OU2 ASP AEP</pre>
--	---------------------------------

## 9.3 Settings for consumed quantity monitoring

### 9.3.1 Settings for quantity monitoring via pulse output

<ul style="list-style-type: none"><li>▶ Select [OU1] and set [ImP].</li><li>▶ Select [ImPS] and set the volumetric flow quantity at which 1 pulse is provided (→ 9.7).</li><li>▶ Select [ImPR] and set [YES].</li><li>&gt; Pulse repetition is active. Output 1 provides a counting pulse each time the value set in [ImPS] is reached.</li></ul>	
---	---

### 9.3.2 Settings for quantity monitoring via the preset counter

<ul style="list-style-type: none"><li>▶ Select [OU1] and set [ImP].</li><li>▶ Select [ImPS] and set the volumetric flow quantity at which output 1 switches (→ 9.7).</li><li>▶ Select [ImPR] and set [no].</li><li>&gt; Pulse repetition is not active. The output switches ON if the value set in [ImPS] is reached. It remains set until the counter is reset.</li></ul>	
--	---

### 9.3.3 Settings for program-controlled counter reset

<ul style="list-style-type: none"><li>▶ Select [rTo] and continue with a) or b)<ul style="list-style-type: none"><li>a) Reset the counter manually</li><li>▶ Press [Set] until [rES.T] is displayed, then briefly press [Mode/Enter].</li><li>b) Enter the value for time-controlled reset</li><li>▶ Press [Set] until the requested value is displayed (intervals from 1 hour to 8 weeks), then briefly press [Mode/Enter].</li><li>▶ Press [Set] until [rES.T] is displayed, then briefly press [Mode/Enter].</li></ul></li></ul>	
---	--

### 9.3.4 Deactivation of the counter reset

<ul style="list-style-type: none"><li>▶ Select [rTo] and set [OFF]. The meter is only reset after overflow (= factory setting).</li></ul> <p>Overflow: After the maximum value (9,999,999 Nm<sup>3</sup>) the counter is reset to 0.</p>	
--	---

### 9.3.5 Counter reset using an external signal

<ul style="list-style-type: none"><li>▶ Select [OU2] and [InD].</li><li>▶ Select [Din2] and set the reset signal.<ul style="list-style-type: none"><li>- [HIGH] = reset for high signal</li><li>- [LOW] = reset for low signal</li><li>- [+EDG] = reset for rising edge</li><li>- [-EDG] = reset for falling edge</li></ul></li></ul>	
---	---



LED 7 (→ 7 Operating and display elements) indicates the input status also with an active external reset.

## 9.4 Settings for temperature monitoring

### 9.4.1 Settings for limit value monitoring with OUT2

<ul style="list-style-type: none"> <li>▶ Select [SEL2] and set [TEMP].</li> <li>▶ Select [OU2] and set the switching function.             <ul style="list-style-type: none"> <li>- [Hno] = hysteresis function/NO</li> <li>- [Hnc] = hysteresis function/NC</li> <li>- [Fno] = window function/NO</li> <li>- [Fnc] = window function/NC</li> </ul> </li> <li>▶ Select [SP2] and set the value at which the output switches.</li> <li>▶ Select [rP2] and set the value at which the output switches back.</li> </ul>	<pre> SEL2 OU2 SP2 rP2             </pre>
--	---

UK

### 9.4.2 Setting the analogue value for temperature

<ul style="list-style-type: none"> <li>▶ Select [SEL2] and set [TEMP].</li> <li>▶ Select [OU2] and set the function.             <ul style="list-style-type: none"> <li>- [I] = temperature-proportional current signal (4...20 mA)</li> </ul> </li> <li>▶ Select [ASP] and set the value at which the minimum value is provided.</li> <li>▶ Select [AEP] and set the value at which the maximum value is provided.</li> </ul>	<pre> SEL2 OU2 ASP AEP             </pre>
--	---

## 9.5 User settings (optional)

### 9.5.1 Setting of the standard unit of measurement for volumetric flow

<ul style="list-style-type: none"> <li>▶ Select [Uni] and set the unit of measurement.             <ul style="list-style-type: none"> <li>- [nm3min] = volumetric flow quantity in standard cubic metres / minute</li> <li>- [nm3h] = volumetric flow quantity in standard cubic metres / hour</li> <li>- [nmS] = current flow velocity in standard metres / second</li> </ul> </li> </ul> <p>The setting only has an effect on the volumetric flow value.</p>	<pre> Uni             </pre>
--	------------------------------

### 9.5.2 Configuration of the standard display

<ul style="list-style-type: none"> <li>▶ Select [SELd] and determine the standard measuring unit.             <ul style="list-style-type: none"> <li>- [FLOW] = the current volumetric flow value in the standard unit of measurement is displayed</li> <li>- [TOTL] = the current meter reading in Nm<sup>3</sup> or 1000 Nm<sup>3</sup> is displayed.</li> <li>- [TEMP] = the current medium temperature in °C is displayed</li> </ul> </li> <li>▶ Select [diS] and set the update rate and orientation of the display.             <ul style="list-style-type: none"> <li>- [d1] = update of the measured values every 50 ms</li> <li>- [d2] = update of the measured values every 200 ms</li> <li>- [d3] = update of the measured values every 600 ms</li> <li>- [rd1], [rd2], [rd3] = display as for d1, d2, d3; rotated by 180°</li> <li>- [OFF] = the display is switched off in the operating mode; when pressing the button the process value is displayed for 15 s.</li> </ul> </li> </ul>	<pre> SELd diS             </pre>
--	-----------------------------------

### 9.5.3 Setting of measured value damping

- ▶ Select [dAP] and set the damping constant in seconds (t value 63 %).

dAP

### 9.5.4 Setting of the error behaviour of the outputs

- ▶ Select [FOU1] and set the value
  - [On] = output 1 switches ON in case of a fault.
  - [OFF] = output 1 switches OFF in case of a fault.
- > For both values ([ON] and [OFF]) the counter stops counting in case of a fault.
  - [OU] = output 1 switches irrespective of the error as defined with the parameters.
- ▶ Select [FOU2] and set the value
  - [On] = output 2 switches ON in case of a fault, the analogue signal goes to the upper end stop value (22 mA).
  - [OFF] = output 2 switches OFF in case of a fault, the analogue signal goes to the lower end stop value (3.5 mA).
  - [OU] = output 2 switches irrespective of the error as defined with the parameters. The curve of the analogue signal corresponds to IEC60947-5-7 (→ diagram in 4.6).

FOU1  
FOU2

### 9.5.5 Setting of the standard pressure to which the measured and display values for volumetric flow refer

- ▶ Select [rEF.P] and set the requested standard pressure.  
Setting range: 950...1050 hPa in steps of 1 hPa.

r-EP.P

### 9.5.6 Setting of the standard temperature to which the measured and display values for volumetric flow refer

- ▶ Select [rEF.T] and set the requested standard temperature.  
Setting range: 0...25 °C in steps of 1 °C.

r-EP.T

### 9.5.7 Setting of the low flow cut-off

- ▶ Select [LFC] and set the limit value.  
Setting range: 2...7 Nm<sup>3</sup>/h in steps of 1 Nm<sup>3</sup>/h.

LFC

## 9.6 Service functions

### 9.6.1 Reading of the min/max values for the volumetric flow

<ul style="list-style-type: none"> <li>▶ Select [HI] or [LO], briefly press [Set]. [HI] = maximum value, [LO] = minimum value</li> </ul> <p>Delete memory</p> <ul style="list-style-type: none"> <li>▶ Select [HI] or [LO].</li> <li>▶ Press [Set] and keep it pressed until [----] is displayed.</li> <li>▶ Press [Mode/Enter] briefly.</li> </ul> <p>It makes sense to delete the memories as soon as the unit operates under normal operating conditions for the first time.</p>	
---	---

### 9.6.2 Reset of all parameters to factory setting

<ul style="list-style-type: none"> <li>▶ Select [rES].</li> <li>▶ Press [Set] and keep it pressed until [----] is displayed.</li> <li>▶ Press [Mode/Enter] briefly.</li> </ul> <p>For the factory settings please refer to the end of these instructions (→ 12 Factory setting). We recommend taking down your own settings in that table before carrying out a reset.</p>	
--	---

 After reset to factory setting the value of the memory is set at zero.

## 9.7 Setting of the preset counter / the pulse value (ImPS)

The unit has 7 setting ranges:

	LED	Display	Step increment	Setting range
1	4	0 . 0 1 0 ... 9 . 9 9 0	0.010 Nm <sup>3</sup>	0.010...9.990 Nm <sup>3</sup>
2	4	1 0 . 0 0 ... 9 9 . 9 9	0.010 Nm <sup>3</sup>	10.00...99.99 Nm <sup>3</sup>
3	4	1 0 0 . 0 ... 9 9 9 . 9	0.1 Nm <sup>3</sup>	100.0...999.9 Nm <sup>3</sup>
4	4	1 0 0 0 ... 9 9 9 9	1 Nm <sup>3</sup>	1,000...9,999 Nm <sup>3</sup>
5	4 + 6	1 0 . 0 0 ... 9 9 . 9 9	10 Nm <sup>3</sup>	10,000...99,990 Nm <sup>3</sup>
6	4 + 6	1 0 0 . 0 ... 9 9 9 . 9	100 Nm <sup>3</sup>	100,000...999,900 Nm <sup>3</sup>
7	4 + 6	1 0 0 0 ... 4 0 0 0	1,000 Nm <sup>3</sup>	1,000,000 Nm <sup>3</sup> ...4,000,000 Nm <sup>3</sup>

## Setting operation:

- ▶ Set [OU1] to [ImP] (→ 9.3.2).
- ▶ Press [Mode/Enter] until [ImPS] is displayed.
- ▶ Press [Set] and keep it pressed.
- > The current numerical value flashes for 5 s, then one of the 4 digits becomes active (digit flashes, can be changed).
- ▶ Set the requested pulse value as shown in the following table.
  - ▶ First select the requested setting range (1, 2, 3): keep the set button pressed until the setting range has the requested value.
  - ▶ Then set the value from left (first digit) to right (fourth digit).
- ▶ Press [Mode/Enter] briefly when all 4 digits are set.

As soon as the first digit flashes there are 3 options:

<p>▶ Briefly press [Set] 1 x</p>	<p>The flashing digit increments. 9 is followed by 0 - 1 - 2, etc.</p> <div style="text-align: right;"> <table border="1" style="display: inline-table; margin-right: 20px;"> <tr><td>8</td><td>1.</td><td>2</td><td>3</td></tr> </table>             [SET] pressed 1 x <table border="1" style="display: inline-table; margin-right: 20px;"> <tr><td>9</td><td>1.</td><td>2</td><td>3</td></tr> </table>             [SET] pressed 1 x <table border="1" style="display: inline-table; margin-right: 20px;"> <tr><td>0</td><td>1.</td><td>2</td><td>3</td></tr> </table>             [SET] pressed 1 x <table border="1" style="display: inline-table;"> <tr><td>1</td><td>1.</td><td>2</td><td>3</td></tr> </table> </div>	8	1.	2	3	9	1.	2	3	0	1.	2	3	1	1.	2	3								
8	1.	2	3																						
9	1.	2	3																						
0	1.	2	3																						
1	1.	2	3																						
<p>▶ Press [Set] and keep it pressed</p>	<p>The flashing digit increments, 9 is followed by 0 and the next digit on the left becomes active.</p> <div style="text-align: right;"> <table border="1" style="display: inline-table; margin-right: 20px;"> <tr><td>8</td><td>1.</td><td>7</td><td>3</td></tr> </table>             [Set] permanently pressed <table border="1" style="display: inline-table; margin-right: 20px;"> <tr><td>8</td><td>1.</td><td>9</td><td>3</td></tr> </table>             [Set] kept pressed <table border="1" style="display: inline-table;"> <tr><td>8</td><td>1.</td><td>0</td><td>3</td></tr> </table> </div> <p>If digit 1 is increased this way, the display changes to the next higher setting range (9 is followed by 10; the decimal point is moved one digit to the right or the LED display changes to the 10<sup>3</sup> exponential notation).</p> <div style="text-align: right;"> <table border="1" style="display: inline-table; margin-right: 20px;"> <tr><td>7</td><td>1.</td><td>2</td><td>3</td></tr> </table>             [Set] permanently pressed <table border="1" style="display: inline-table; margin-right: 20px;"> <tr><td>9</td><td>1.</td><td>2</td><td>3</td></tr> </table>             [Set] kept pressed <table border="1" style="display: inline-table;"> <tr><td>1</td><td>0</td><td>1.</td><td>2</td></tr> </table> </div>	8	1.	7	3	8	1.	9	3	8	1.	0	3	7	1.	2	3	9	1.	2	3	1	0	1.	2
8	1.	7	3																						
8	1.	9	3																						
8	1.	0	3																						
7	1.	2	3																						
9	1.	2	3																						
1	0	1.	2																						

<p>► Wait 3 s (do not press any button).</p>	<p>The next digit on the right flashes (= becomes active).</p> <p style="text-align: right;">8 1 2. 3</p> <p style="text-align: right;">No button pressed; after 3 s 8 1 2. 3</p> <p style="text-align: right;">after 3 s 8 1 2. 3</p> <p style="text-align: right;">after 3 s 8 1 2. 3</p>
	<p>If the 4th digit flashes for 3 s without being changed, digit 1 becomes active again if it has a value &gt; 0.</p> <p style="text-align: right;">after 3 s 8 1 2. 3</p> <p>If digit 1 has the value "0", the display changes to the next lower setting range (the decimal point is moved one digit to the left or the LED display changes to the 10<sup>3</sup> exponential notation).</p> <p style="text-align: right;">0 1 2. 3</p> <p style="text-align: right;">after 3 s 1 2. 3 0</p> <p style="text-align: center;">Next: change digit 4 or wait 3 s and set digit 1.</p> <p style="text-align: right;">after 3 s 1 2. 3 0</p>

UK



- Numbers highlighted grey (e.g. 1) = flashing digit.
- if [Set] is pressed continuously, the display moves through all ranges; after the end value it jumps back to the start value. After this, release [Set] briefly and start the setting again.

## 10 Operation

Correct operation and compliance with the measurement accuracy can only be ensured if the environmental conditions specified in the technical data are adhered to. Ensure that the maximum pressure range, measuring range and permitted operating temperature are not exceeded.

After power on and expiry of the power-on delay time (approx. 1 s) the unit is in the Run mode (= normal operating mode). It carries out its measurement and evaluation functions and generates output signals according to the set parameters.

- Operation indication → chapter 7 Operating and display elements.
- During the power-on delay time the outputs are switched as programmed: ON for NO function (Hno, Fno), OFF for NC function (Hnc, Fnc).
- If output 2 is configured as analogue output, the output signal is at the final value of the measuring range during the power-on delay time.



## 10.1 Reading of set parameters

- ▶ Press [Mode/Enter] until the requested parameter is displayed.
- ▶ Press [Set] briefly.
- > The unit displays the corresponding parameter value. After about 15 s (from menu level 1) or 30 s (from menu level 2) it again displays the parameter, then it returns to the Run mode.

## 10.2 Changing the display unit in the Run mode

- ▶ Press [Set] briefly in the Run mode. Press the pushbutton to move to the next display unit.
- > The unit displays the current measured value in the selected display for approx. 15 s, the corresponding LED is lit.

## 10.3 Error indications

[SC1]	Short circuit in OUT1*
[SC2]	Short circuit in OUT2*
[SC]	Short circuit in both outputs*
[OL]	Measured value > 120 % of the final value of the measuring range
[UL]	Measured value < -20 % of the final value of the measuring range (temperature)
[Err]	Flashing: error in the measuring probe or measured value > 130 % of the final value of the measuring range

\*The output concerned is switched off as long as the short circuit exists.  
These messages are displayed even if the display is switched off.

## 10.4 General operating conditions

The unit is maintenance-free for media which do not stick to the measuring probes.

- From time to time check the measuring probes visually for build-up.
- If necessary, clean them at regular intervals. To do so, use a suitable cleaning liquid (e.g. alcoholic solution).
- Avoid mechanical damage to the measuring probes.

## 11 Technical data and scale drawing

Technical data and scale drawing at [www.ifm.com](http://www.ifm.com) → Data sheet search → Enter the article number.



## 12 Factory setting

	Factory setting	User setting
SP1	140	
rP1	137	
ImPS	0.010	
ImPR	YES	
OU1	Hno	
OU2	I	
SP2 (FLOW)	280	
rP2 (FLOW)	277	
SP2 (TEMP)	24.0	
rP2 (TEMP)	23.8	
ASP (FLOW)	0	
AEP (FLOW)	700	
ASP (TEMP)	0.0	
AEP (TEMP)	60.0	
DIn2	+EDG	
FOU1	OFF	
FOU2	OFF	
dAP	0.6	
rTo	OFF	
diS	d3	
Uni	nm3h	
SELd	FLOW	
SEL2	FLOW	
rEF.P	1013	
rEF.T	15	
LFC	2	

More information at [www.ifm.com](http://www.ifm.com)