



Operating instructions  
Combined sensor for pump diagnosis  
and pressure monitoring

**PIM693**  
**PIM694**

**UK**

114256176 / 00 11 / 2021



# Contents

1 Preliminary note.....	3
1.1 Symbols used.....	3
2 Safety instructions .....	3
3 Brief instructions .....	4
4 Functions and features .....	6
5 Function.....	6
5.1 Processing of the measured signals.....	6
5.2 Pump monitoring .....	6
5.3 Pressure monitoring/ analogue function .....	8
5.4 Pressure monitoring / switching function .....	9
6 Installation.....	10
7 Electrical connection.....	12
8 Operating and display elements .....	13
9 Menu.....	14
9.1 Menu structure.....	14
9.2 Menu explanation .....	15
10 Parameter setting .....	16
10.1 Parameter setting general .....	16
10.2 Configuring unit for pump diagnosis .....	18
10.3 Configuring unit for pressure monitoring .....	20
10.4 User settings (optional) .....	21
10.5 Service functions .....	22
11 Operation .....	22
11.1 Read the set parameter values.....	22
11.2 Changing the display in the Run mode .....	23
11.3 Fault indication.....	23
12 Setting ranges.....	24
13 Factory setting .....	25

# 1 Preliminary note

## 1.1 Symbols used

- ▶ Instruction
- > Reaction, result
- [...] Designation of buttons, switches or indications
- Cross-reference



Important note

Non-compliance can result in malfunctions or interference.

UK

## 2 Safety instructions

- The device described is a subcomponent for integration into a system.
  - The manufacturer is responsible for the safety of the system.
  - The system manufacturer undertakes to perform a risk assessment and to create a documentation in accordance with legal and normative requirements to be provided to the operator and user of the system. This documentation must contain all necessary information and safety instructions for the operator, the user and, if applicable, for any service personnel authorised by the manufacturer of the system.
- Read this document before setting up the product and keep it during the entire service life.
- The product must be suitable for the corresponding applications and environmental conditions without any restrictions.
- Only use the product for its intended purpose (→ Functions and features).
- Only use the product for permissible media (→ Technical data).
- If the operating instructions or the technical data are not adhered to, personal injury and/or damage to property may occur.
- The manufacturer assumes no liability or warranty for any consequences caused by tampering with the product or incorrect use by the operator.
- Installation, electrical connection, set-up, programming, configuration, operation and maintenance of the product must be carried out by personnel qualified and authorised for the respective activity.
- Protect units and cables against damage.



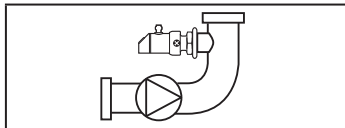

### 3 Brief instructions

-  Important for optimum pump diagnosis: Mount the unit as closely to the spout of the pump as possible.



#### Display and operation

The unit features an integrated 4-digit alphanumeric display. On delivery it switches between the two following indications:

<b>1</b>	Bar graph pump diagnosis:  = small deviation from the normal operation  = high deviation from the normal operation  = deviation outside the tolerated rang
<b>2</b>	Current system pressure in bar  160

The bar display visualises the monitoring window for the pump diagnosis. When the current pulsation value exceeds or falls below the limits of the window, the bar is closed. When the current pulsation value is in the middle of the window, the bar is open. The current pulsation value can also be displayed temporarily as a numerical value.

► Press [Set] briefly.

> Indication of the current pulsation value in % (e.g.  430) for 4 min.

There are 2 operating keys below the display:

- [Set]: Setting the parameter values (scrolling by holding pressed); incremental by pressing briefly).
- [Mode/Enter]: Selection of the parameters and acknowledgement of the parameter values.

Each parameter setting requires 3 steps:

1. Selecting parameter:  
Press [Mode/Enter].
2. Setting the parameter value:  
Press [SET] for over 5 s, then set value by keeping the button pressed or by pressing it once.
3. Acknowledge parameter value:  
Press [Mode/Enter] briefly..

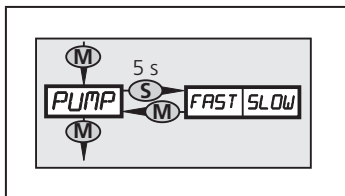

Menu structure and list of parameters that can be set → chapter 9.2.

More information on parameter setting → chapter 9.

## Adjust unit to the installation (teach)

- ▶ Put the installation into operation and use it in normal operation.

NOTE: For the teach operation the pressure must be at least 5% of the final value of the measuring range. For a safe teach operation 10% of the final value of the measuring range is recommended.

- ▶ Select [PUMP], set the requested value:

- [FAST] for fast pumps (more than 200 rpm);
- [SLOW] for slow pumps (40...300 rpm).

Pumps with a rotational speed below 40 rpm cannot be monitored.

- ▶ Select [tPu1], then press [Set] and keep the button pressed.

- > [tch] flashes, first slowly, then quickly.

- ▶ Release [Set].

- > After approx. 20 s [tch] is displayed continuously.

- ▶ Press [Mode/Enter] briefly (= acknowledgement).

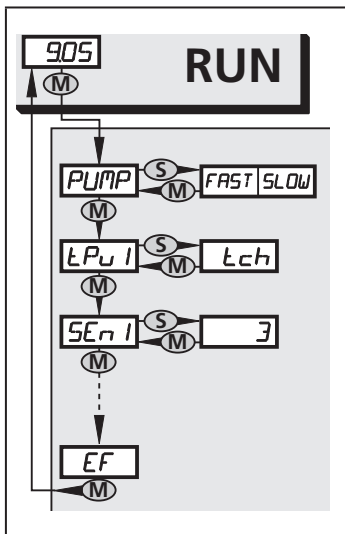

## Testing the diagnostic function

- ▶ Put the unit into the operational status at which the alarm is to be triggered.

Change several times between normal operation and faulty operation.

If OUT1 remains unchanged in normal operation but switches in the event of faults, the process has been completed.

If OUT1 does not switch as requested: make a fine adjustment:

- ▶ Select [SEn1] and set a value between 1 and 20. The value indicates the upper and lower tolerance limits for pulsation; 1 = lowest, 20 = highest tolerance (→ 10.2.4).

Further menu items for the optimisation of the diagnostic function: HSP, LSP  
→ 10.2.7.

## 4 Functions and features

The unit monitors the operating state of pumps and the system pressure of machines and installations.

### Applications

Type of pressure: relative pressure



Information on pressure rating and bursting pressure → data sheet.



Static and dynamic overpressures exceeding the indicated overload pressure are to be avoided by taking appropriate measures.

The indicated bursting pressure must not be exceeded. Even if the bursting pressure is exceeded only for a short time, the unit can be destroyed. NOTE: Risk of injury!

## 5 Function

### 5.1 Processing of the measured signals

- The unit analyses the pulsation characteristics of the pump and signals the deviations from the basic characteristic determined for normal operation.
- It detects the system pressure and evaluates the measuring signal.

2 outputs are available for the signal output:

- Output 1:
  - Signal for pump diagnosis; adjustable window function, normally open or normally closed.
- Output 2:
  - 2 configuration options:
    - Analogue signal proportional to the pressure (4...20 mA or 20...4 mA, scaleable).
    - Switching signal for the system pressure; adjustable to hysteresis or window function, normally open or normally closed.

### 5.2 Pump monitoring

When pumps are operated, pulsation patterns occur in the pressure pipe. They are high-frequency minimum pressure fluctuations superimposing the standard curve of the system pressure.

The pulsation pattern depends on the operating status of the pump. In normal operation a characteristic standard pattern occurs. It changes under non-standard operating conditions.

Examples for non-standard operating conditions:

- cavitation (due to reduced cross-section, e.g. filter clogging, closed slide or low supply pressure),
- air/gas inclusion, partial running dry or running dry,
- wear of the pump,
- blockage of the pump.

## Evaluation of the pulsation pattern

UK

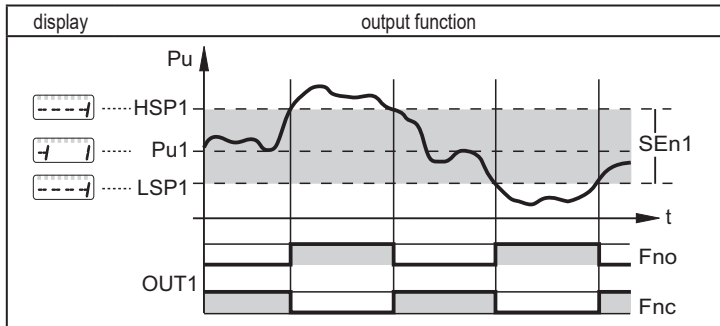

$P_u$  = numerical value pulsation.



$P_{u1}$  = mean value of pulsation in normal operation. The value is defined by the teach process ( $\rightarrow$  10.2.2), however, it can also be entered manually ( $\rightarrow$  10.2.7). It does not have any effect on the output; it only controls the bar display (for pulsation value =  $P_{u1}$  the bar is open).

HSP1 = upper limit value, LSP1 = lower limit value for the pulsation. The values are automatically defined during the teach process, however, they can also be entered manually ( $\rightarrow$  10.2.7). With pulsation  $\geq$  HSP1 or pulsation  $\leq$  LSP1 the bar is closed.

SEn1 = tolerance range for pulsation (symmetrical with the taught pulsation value  $P_{u1}$ ).

Fno = OUT1 in normally open operation (Out1 = ON if the value increases above HSP1 and decreases below LSP1); Fnc = OUT1 in normally closed operation.

The graphics display is independent of the setting for OUT1.

- The pulsation pattern occurred in normal operation is detected. It is converted into a numerical value (Pu1) which the unit stores as the standard value; bar graph: closed .
- The standard value can be fixed automatically by teaching or manually ( $\rightarrow 10.2$ ).
- During operation the pulsation pattern is constantly monitored. If it is different from the standard value and exceeds the tolerance range SE<sub>n1</sub> (= the defined limits HSP1 and LSP1), output 1 changes its switching status; the bar graph closes .
- The switching signals can be directly used for maintenance or active pump control.

### 5.3 Pressure monitoring/ analogue function

The analogue signal can be set:

- [OU2] defines whether the set measuring range is provided as a 4...20 mA signal ([OU2] = [I]) or a 20...4 mA signal ([OU2] = [InEG]).
- [ASP] defines the measured value at which the output signal is 4 mA (20 mA at [InEG]).
- [AEP] defines the measured value at which the output signal is 20 mA (4 mA at [InEG]).

Minimum distance between [ASP] and [AEP] = 25 % of the final value of the measuring range (turn down 1:4).

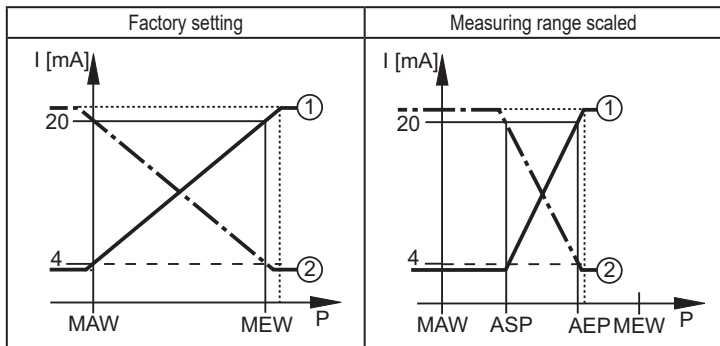

P = system pressure, MAW = initial value of the measuring range, MEW = final value of the measuring range

①: [OU2] = [I]; ②: [OU2] = [InEG]



In the set measuring range the output signal is between 4 and 20 mA / 20 and 4 mA.

Also signalled:

- System pressure above the measuring range:
  - output signal > 20 mA at [OU2] = [I],
  - the output signal drops to maximum 3.8 mA at [OU2] = [InEG].
- System pressure below the measuring range:
  - the output signal drops to maximum 3.8 mA at [OU2] = [I],
  - output signal > 20 mA at [OU2] = [InEG].

## 5.4 Pressure monitoring / switching function

UK

OUT2 changes its switching state if it is above or below the set switching limits (SP2, rP2). The following switching functions can be selected:

- Hysteresis function / normally open: [OU2] = [Hno] (→ fig. 1).
- Hysteresis function / normally closed: [OU2] = [Hnc] (→ fig. 1).

First the set point (SP2) is set, then the reset point (rP2) at the requested distance.

- Window function / normally open: [OU2] = [Fno] (→ fig. 2).
- Window function / normally closed: [OU2] = [Fnc] (→ fig. 2).

The width of the window can be set by means of the distance between SP2 and rP2. SP2 = maximum value, rP2 = minimum value.

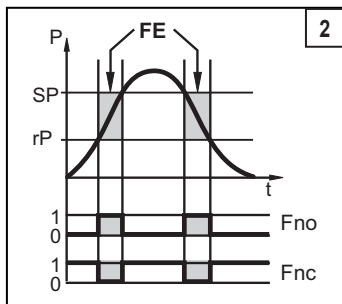
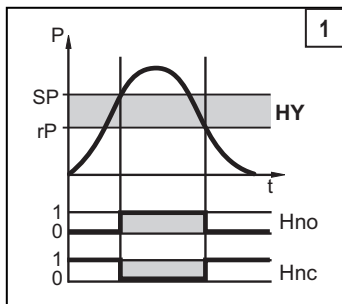

$P$  = system pressure;  $HY$  = hysteresis;  $FE$  = window

## 6 Installation



Ensure that no pressure is applied to the installation while mounting or removing the sensor.

- ▶ Install the unit as closely as possible to the spout of the pump. Only then will the pulsation pattern be optimally transferred to the unit.
- ▶ Slightly grease the thread of the sensor using a lubricating paste which is suitable and approved for the application.
- ▶ Screw the sensor into a G 1 process fitting.
- ▶ Tighten the sensor with a spanner. Tightening torque: 20 Nm.

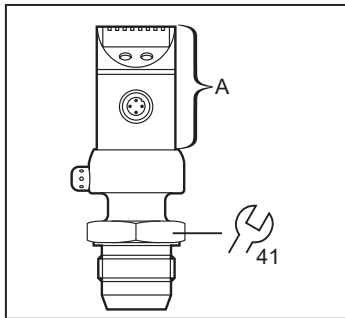
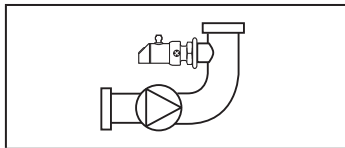

A = freely rotatable housing

The unit is adaptable for various G 1 process fittings. G 1 process adapters to be ordered separately as accessories.

## Mounting

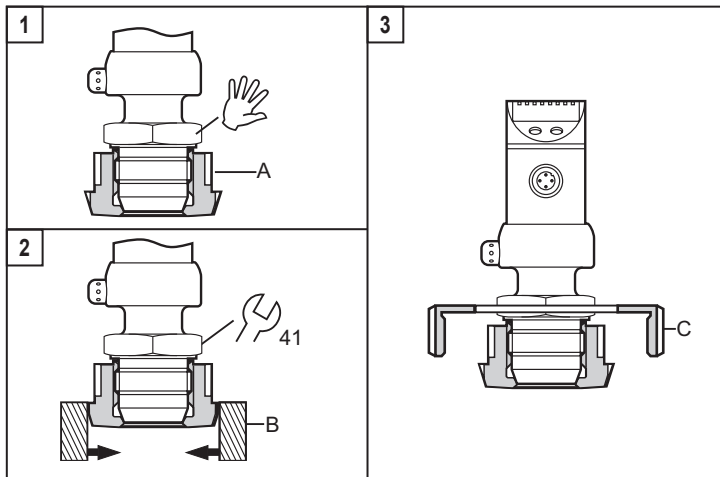

- ▶ Slightly grease the contact areas between the sensor and adapter using a lubricating paste which is suitable and approved for the application.
- ▶ Screw the unit into the adapter (A) until it is hand-tight (fig. 1). Do not damage the sealing chamfers.
- ▶ Clamp sensor and adapter into a clamping device (B); (fig. 2). Tighten the clamping device only slightly so that the adapter does not warp.
- ▶ Tighten the sensor using a spanner .  
Tightening torque: 20 Nm.
- ▶ Fix the unit + adapter to the process connection by means of a coupling nut, a clamp flange or the like (C); (fig 3).

NOTE: A guarantee for a long-term stable sealing of the metal seal is only valid for once-only mounting.

### Welding adapter

- ▶ First weld the adapter, then mount the sensor. Follow the instructions included with the adapter.

## 7 Electrical connection



The unit must be connected by a qualified electrician.

The national and international regulations for the installation of electrical equipment must be adhered to.

Voltage supply to EN50178, SELV, PELV.

- ▶ Disconnect power.
- ▶ Connect the unit as follows:

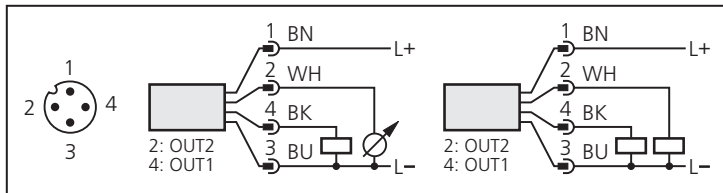

<b>Pin 1</b>	Ub+
<b>Pin 3</b>	Ub-
<b>Pin 4 (OUT1)</b>	binary switching output for pump diagnosis
<b>Pin 2 (OUT2)</b>	signal for pressure monitoring • analogue output if [OU2] = [I] or [InEG] • binary output if [OU2] = [Hno], [Hnc], [Fno] or [Fnc]

Core colours of ifm sockets:

1 = BN (brown), 2 = WH (white), 3 = BU (blue), 4 = BK (black)

## 8 Operating and display elements

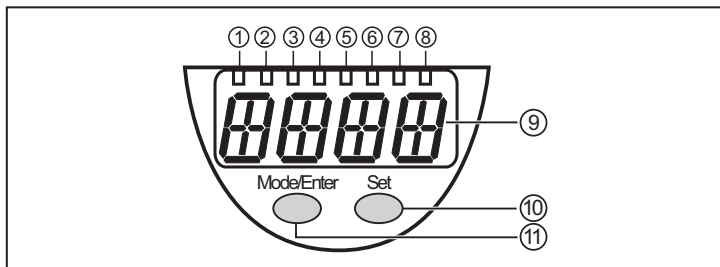

### 1 - 8: Indicating LEDs

- LED 1: green = indication of the system pressure in bar.
- LED 2: green = indication of the system pressure in MPa.
- LED 3: green = indication of the system pressure in PSI.
- LED 4: not used.
- LED 5: green = display mode "bar graph for pump diagnosis" is active.
- LED 6: not used.
- LED 7: yellow = output 2 (pressure monitoring) is switched.
- LED 8: yellow = output 1 (pump diagnosis) is switched.

### 9: Alphanumeric display, 4 digits

- System pressure and bar graph are indicated alternately: ↔ , if [SELD] = [P Pu] is set.
- Bar graph for pump diagnostics (if [SELD] = [Pu] is set).
  - = small deviation from the normal operation.
  - = high deviation from the normal operation.
  - = deviation outside the tolerated range.
- Indication of the system pressure (if [SELD] = [P] is set; e.g. ).
- Display of the parameters and parameter values.

### 10: Set pushbutton

- Setting of the parameter values (scrolling by holding pressed, incremental by pressing briefly).
- Changing the display unit in the Run mode → 11.2.

### 11: Mode/Enter pushbutton



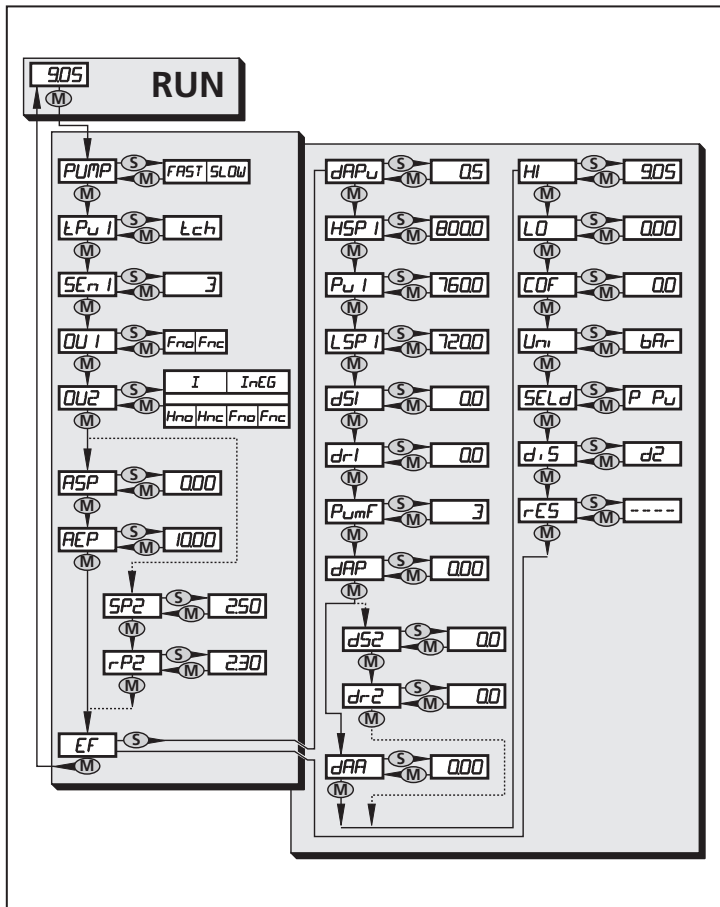

- Selection of the parameters and acknowledgement of the parameter values.

# 9 Menu

## 9.1 Menu structure



## 9.2 Menu explanation



PUMP	Setting to the rotational speed range of the pump monitored.
tPu1	Standard value for teaching the pulsation. (  ).
SEn1	Sensitivity of pump monitoring (tolerance limits for not reaching / exceeding the standard value).
OU1	Switching function for OUT1 (pump diagnosis): window function / normally open [Fno] or window function / normally closed [Fnc].
OU2	Output function for OUT2 (monitoring the system pressure): <ul style="list-style-type: none"> <li>• Switching signal for the limit values: hysteresis function [H ..] or window function [F ..], normally open [. no] or normally closed [. nc] each.</li> <li>• Analogue signal for the current system pressure: 4-20 mA [I] or 20-4 mA [InEG].</li> </ul>
ASP	Analogue start point for the system pressure: measured value at which 4 mA are output (20 mA on OU2 = InEG).
AEP	Analogue end point for the system pressure: measured value at which 20 mA are output (4 mA / on OU2 = InEG).
SP2 / rP2	Upper / lower limit value for the system pressure.
EF	Extended functions / Opening menu level 2.
dAPu	Damping the pulsation value.
HSP1	Upper switching limit for pulsation value (  ).
PU1	Average pulsation value (  ).
LSP1	Lower switching limit for pulsation value (  ).
dS1	Switch-on delay for OUT1.
dr1	Reset delay for OUT1.
PumF	Read / enter the characteristic value for the pulsation frequency.
dAP	Damping of the measured value for the signal "pressure monitoring".
dS2	Switch-on delay for OUT2.
dr2	Reset delay for OUT2.
dAA	Damping for the analogue signal "system pressure".
HI	Maximum value memory for the system pressure.
LO	Minimum value memory for the system pressure.
COF	Zero point calibration.
Uni	Standard unit of measurement for the system pressure.
SEld	Display mode: system pressure or bar graph for pump diagnosis or change between them.
diS	Update rate and orientation of the display.
rES	Restore the factory setting.

## 10 Parameter setting

During the parameter setting process the unit remains in the operating mode. It continues its monitoring function with the existing parameters until parameter setting has been terminated.

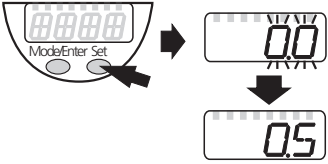

### 10.1 Parameter setting general

Each parameter setting requires 3 steps:

<b>1 Selecting parameter</b> ▶ Press [Mode/Enter] until the requested parameter is displayed.	
<b>2 Setting the parameter value</b> ▶ Press [Set] and keep the button pressed. > Current setting value of the parameter bit flashes for 5 s. > After 5 s: Setting value is changed: incremental by pressing briefly or scrolling by holding pressed.	
The numerical values are incremented continuously. If the value is to be reduced: Let the display move to the maximum setting value. Then the cycle starts again at the minimum setting value.	
<b>3 Acknowledge parameter value</b> ▶ Press [Mode/Enter] briefly. > The parameter is displayed again. The new setting value is stored.	
<b>Set more parameters:</b> ▶ Start again with step 1.	
<b>Finishing parameter setting:</b> ▶ Press [Mode/Enter] several times until the current measured value is displayed or wait for 15 s. The unit returns to the operating mode if no button is pressed for over 15 s after acknowledgement of the new parameter value.	



- Changing from menu level 1 to menu level 2:

<ul style="list-style-type: none"> <li>▶ Press [Mode/Enter] until [EF] is displayed.</li> </ul>	
<ul style="list-style-type: none"> <li>▶ Press [Set] briefly.</li> <li>&gt; The first parameter of the submenu is displayed (here: [dAPu]).</li> </ul>	

- Locking / unlocking

UK

The unit can be locked electronically to prevent unintentional wrong settings.

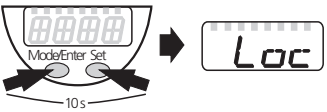
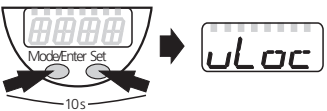
<ul style="list-style-type: none"> <li>▶ Ensure that the unit is in the normal operating mode.</li> <li>▶ Press [Mode/Enter] + [Set] for 10 s.</li> <li>&gt; [Loc] is displayed.</li> </ul>	
<p>During operation: &gt; [Loc] is displayed briefly when you try to change parameter values.</p>	
<p>For unlocking:</p> <ul style="list-style-type: none"> <li>▶ Press [Mode/Enter] + [Set] for 10 s.</li> <li>&gt; [uLoc] is displayed.</li> </ul>	

On delivery: Unlocked.

- Timeout:

If no button is pressed for 15 s while the parameters are being set, the unit returns to the operating mode with unchanged values.

## 10.2 Configuring unit for pump diagnosis

### 10.2.1 Adjusting to the pump

- ▶ Select [PUMP], set the requested value:  
[FAST] for fast pumps (more than 200 rpm);  
[SLOW] for slow pumps (40...300 rpm).  
Pumps with a rotational speed below 40 rpm cannot be monitored.

**PUMP**

### 10.2.2 Teaching the normal value

- ▶ Put the installation into operation and use it in normal operation.  
NOTE: If teaching is carried out at pressures below 10 % of the final value of the measuring range, the diagnostic function may provide wrong values.
- ▶ Select [tPu1], press [Set] and keep the button pressed.
  - > [tch] flashes, first slowly, then quickly.
- ▶ Release [Set].
  - > After approx. 20 s [tch] is displayed continuously.
  - If [UL] is displayed, the system pressure for a teach operation is too low (system pressure < 5% of the final value of the measuring range). The process was stopped.
- ▶ Press [Mode/Enter] briefly (= acknowledgement).
  - > The mean pulsation value in normal operation (Pu1), the tolerance range (SEn1) and thus the limits of the monitoring window HSP1 and LSP1 are defined.

**tPu1**

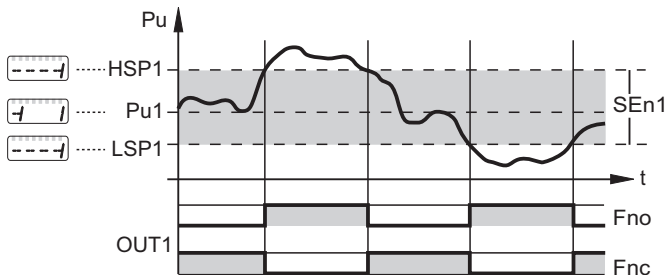

### 10.2.3 Testing the diagnostic function

- ▶ Put the unit into the operational status at which the alarm is to be triggered. Change several times between normal operation and faulty operation.  
If OUT1 remains unchanged in normal operation but switches in the event of faults, the process has been completed. If OUT1 does not switch as requested: Make fine adjustments(→ 10.2.4 / 10.2.6 / 10.2.7).

<b>10.2.4 Adapting the sensitivity (optional)</b>	
<ul style="list-style-type: none"> <li>▶ Select [SEn1] and set a value between 1 and 20. The value determines the upper and lower tolerance limit for pulsation (→ fig. 10.2.2; 1 = lowest, 20 = highest tolerance).</li> <li>▶ Test function again, adjust SEN1 value, if required, or optimise the diagnostic function → 10.2.7.</li> </ul>	SEn 1
<b>10.2.5 Setting the output signal</b>	
<ul style="list-style-type: none"> <li>▶ Select [OU1] and set the switching functions: [Fno] = window function / normally open, [Fnc] = window function / normally closed. Optional: Set the switch-on delay [dS1] or the reset delay [dr1]:</li> <li>▶ Select [dS1] or [dr1], set value between 0.1 and 50.0 s (at 0.0 the delay time is not active).</li> </ul>	OU 1 dS 1 dr 1
<b>10.2.6 Dampen process value “pulsation” (optional)</b>	
<p>Goal: Stabilise the switching characteristics and the bar graph.</p> <ul style="list-style-type: none"> <li>▶ Select [dAPu] and set value between 0.1 and 50.0 s (0.0 = [dAPu] is not active). dAPu value = time during which the pulsation increases to 63% of the maximum value.</li> </ul>	dAPu
<b>10.2.7 Optimising the diagnostic function (optional)</b>	
<p>Only if required: If deviations are not always safely detected.</p> <ul style="list-style-type: none"> <li>▶ Put the installation into operation and use it in normal operation.</li> <li>▶ Press [Set] briefly.</li> <li>&gt; The current pulsation values are displayed for 4 minutes (if [SEld] = [P Pu]; → 10.4.2).</li> <li>▶ Watch the display during this time. Note down the average value, the maximum value and the minimum value.</li> <li>▶ Select [HSP1] and enter the upper limit value for the monitoring window (→ fig. 10.2.2). It has to be greater than or equal to the maximum value noted down. The more HSP1 is above the minimum value noted down, the larger the tolerance against fluctuations of the pulsation value.</li> <li>▶ Select [Pu1] and enter the mean value noted down. It does not have any effect on the output; it only controls the bar display (for pulsation = Pu1 the bar is open).</li> </ul> <p>continue → next page</p>	HSP 1 Pu 1 LSP 1

<p>Select [LSP1] and enter the lower limit value for the monitoring window (→ fig. 10.2.2). It has to be smaller than or equal to the minimum value noted down.</p> <p>The more LSP1 is below the minimum value noted down, the larger the tolerance against fluctuations of the pulsation value.</p> <p>ATTENTION: [HSP1] always has to be greater than [Pu1], [LSP1] always has to be smaller than [Pu1].</p> <p>If a value to be newly entered is greater or smaller than the neighbouring value, the neighbouring value has to be changed accordingly beforehand.</p> <p>Examples: If a value is to be entered for [Pu1] that is greater than the current value for [HSP1], the HSP1 value has to be increased beforehand. If a value is to be entered for [HSP1] that is smaller than the current value for [Pu1], the Pu1 value has to be decreased beforehand.</p>	<h1>LSP 1</h1>
---	----------------

## 10.3 Configuring unit for pressure monitoring

<h3>10.3.1 Setting the output function</h3>	
<p>▶ Select [OU2] and set the function:          [Hno] = hysteresis function / normally open,          [Hnc] = hysteresis function / normally closed,          [Fno] = window function / normally open,          [Fnc] = window function / normally closed.          [I] = current signal proportional to the pressure 4...20 mA,          [InEG] = current signal proportional to the pressure 20...4 mA.</p>	<h1>OU2</h1>
<h3>10.3.2 Scaling the analogue value</h3>	
<p>▶ Select [ASP] and set measured value at which 4 mA are output (20 mA at [OU2] = [InEG]).</p>	<h1>ASP</h1>
<p>▶ Select [AEP] and set measured value at which 20 mA are output (4 mA at [OU2] = [InEG]).</p> <p>Minimum distance between ASP and AEP = 25 % of the final value of the measuring range (scaling factor 1:4).</p>	<h1>AEP</h1>
<p>Optional: Damping analogue signal "system pressure":</p> <p>▶ Select [dAA] and set value between 0.01 and 10.00 s (at 0.00 [dAA] is not active).</p> <p>dAA value = response time between pressure change and change of the analogue value in seconds.</p>	<h1>dAA</h1>

<b>10.3.3 Setting the switching limits</b>	
<ul style="list-style-type: none"> <li>▶ Select [SP2] and set the measured value at which the output switches.</li> </ul>	SP2
<ul style="list-style-type: none"> <li>▶ Select [rP2] and set the measured value at which the output switches back.</li> </ul> <p>rP2 is always lower than SP2. The unit only accepts values which are lower than SP2.</p>	rP2
<p>Optional: Damping the switching signal "pressure monitoring":</p> <ul style="list-style-type: none"> <li>▶ Select [dAP] and set value between 0.01 and 10.00 s (at 0.00 = [dAP] is not active).</li> </ul> <p>dAP value = response time between pressure change and change of the switching status in seconds. [dAP] influences the switching frequency: <math>f_{\max} = 1 \div 2dAP</math>.</p>	dAP
<p>Optional: Fix switch-on delay [dS2] or reset delay [dr2]:</p> <ul style="list-style-type: none"> <li>▶ Select [dS2] or [dr2], set value between 0.1 and 50.0 s (at 0.0 the delay time is not active).</li> </ul>	dS2 dr2

UK

## 10.4 User settings (optional)

<b>10.4.1 Setting the standard unit of measurement for the system pressure</b>	
<ul style="list-style-type: none"> <li>▶ Select [Uni] and set the unit of measurement: [bAr], [MPa] or [PSI].</li> </ul>	Uni
<b>10.4.2 Configuring the display</b>	
<ul style="list-style-type: none"> <li>▶ Select [SELd] and set the type of display: [P]: System pressure in the unit set in Uni <input type="text" value="160"/>. [Pu]: Bar graph for pump diagnosis <input type="text" value="4"/>. [P Pu]: System pressure / bar graph for pump diagnosis alternately <input type="text" value="4"/> ↔ <input type="text" value="160"/>.</li> <li>▶ Select [diS] and set update rate and orientation of the display: [d1]: Update of the measured value every 50 ms. [d2]: Update of the measured value every 200 ms. [d3]: Update of the measured value every 600 ms. [rd1], [rd2], [rd3]: Display like d1, d2, d3; rotated by 180°. [OFF]: The display is deactivated in the operating mode.</li> </ul>	SELd d, 5
<b>10.4.3 Zero-point calibration</b>	
<ul style="list-style-type: none"> <li>▶ Select [COF] and set a value between -5% and 5% of the final value of the measuring range. The internal measured value "0" is shifted by this amount.</li> </ul>	COF

## 10.5 Service functions

<b>10.5.1 Reading the min./max. values for the system pressure</b>	
<ul style="list-style-type: none"><li>▶ Select [HI] or [LO], press [Set] briefly. [HI] = maximum value, [LO] = minimum value.</li></ul> Delete memory: <ul style="list-style-type: none"><li>▶ Select [HI] or [LO].</li><li>▶ Press [SET] until [----] is displayed.</li><li>▶ Press [MODE/ENTER] briefly.</li></ul>	<i>HI</i> <i>LO</i>
<b>10.5.2 Reset all parameters to the factory setting</b>	
<ul style="list-style-type: none"><li>▶ Select [rES], then press [SET] until [----] is displayed.</li><li>▶ Press [MODE/ENTER] briefly.</li></ul> It makes sense to note down your own settings before executing the function (→ 14 Factory preset).	<i>rES</i>
<b>10.5.3 Read / enter the characteristic value for the pulsation frequency</b>	
<ul style="list-style-type: none"><li>▶ Select [PumF] and press [SET] briefly.</li><li>▶ Read the value and note it down(→ 14 Factory preset). When the unit has been replaced, it can be stored in the new unit: Select [PumF], activate via [Set], enter numerical value.</li></ul>	<i>PumF</i>









## 11 Operation

After power on of the supply voltage the unit is in the Run mode (= normal operation). It carries out its measurement and evaluation functions and generates output signals according to the set parameters.

### 11.1 Read the set parameter values

- ▶ Press [Mode/Enter] briefly to scroll the parameters.
- ▶ Press [Set] briefly to indicate the corresponding parameter value for 15 s. After another 15 s the unit returns to the Run mode.

## 11.2 Changing the display in the Run mode

When alternating indication is selected (  ↔  ; [SELd] = [P PU]):
▶ Press [Set] briefly. > Indication of the current pulsation value in % (e.g.  ) for 4 min.
When pressure indication is selected (  ; [SELd] = [P]):
▶ Press [Set] briefly. > Indication of the deviation of the pulsation from the normal operation for 4 min.  = small deviation from the normal operation.  = high deviation from the normal operation.  = deviation outside the tolerated range.
When the bar graph is selected (  ; [SELd] = [Pu]):
▶ Press [Set] briefly. > Indication of the current system pressure (e.g.  ) for 4 min.

## 11.3 Fault indication

[OL]	overload pressure (measuring range exceeded)
[UL]	underpressure range (measuring range below the minimum value)
[SC1]	short circuit in OUT1*
[SC2]	short circuit in OUT2*
[SC]	short circuit in both switching outputs*
[Err]	internal fault, invalid input

\*The output concerned is switched off as long as the short circuit exists.

[SC1], [SC2], [SC] and [Err] are displayed even if the display is switched off.

## 12 Setting ranges

Upper (SP2) / lower limit value (rP2) for the system pressure; analogue start point (ASP) / analogue end point (AEP) for the system pressure

		SP2		rP2		ASP		AEP		ΔP
		min	max	min	max	min	max	min	max	
<b>PIM693</b>	bar	-0.96	25.00	-1.00	24.96	-1.00	18.74	5.24	25.00	0.02
	PSI	-13.8	362.7	-14.4	362.1	-14.4	271.8	76.2	362.7	0.3
	MPa	-0.096	2.500	-0.100	2.496	-0.100	1.874	0.524	2.500	0.002
<b>PIM694</b>	bar	-0.98	10.00	-1.00	9.98	-1.00	7.50	1.50	10.00	0.01
	PSI	-14.2	145.0	-14.5	144.7	-14.5	108.7	21.8	145.0	0.1
	MPa	-0.098	1.000	-0.100	0.998	-0.100	0.750	0.150	1.000	0.001

ΔP = increments

Parameters for pump diagnosis

SEn1		Pu1		HSP1		LSP1	
min	max	min	max	min	max	min	max
1	20	1	799.9	1.1	800	0	799.8



## 13 Factory setting

	Factory setting	User setting
PUMP	FAST	
SEn1	3	
OU1	Fnc	
OU2	I	
ASP	0% VMR*	
AEP	100% VMR*	
SP2	25% VMR*	
rP2	23% VMR*	
dAPu	3.0	
HSP1	800.0	
Pu1	640.0	
LSP1	480.0	
ds1	0.0	
dr1	0.0	
PumF	3	
dAP	0.06	
ds2	0.0	
dr2	0.0	
dAA	0.00	
COF	0.0	
Uni	bAr	
SELd	P Pu	
dis	d2	

\* = the indicated percentage of the final value of the measuring range (VMR) of the corresponding sensor in bar is set

More information at [www.ifm.com](http://www.ifm.com)